

For your future investment, contact :

Rochelle S. Suarez

 +63 906 778 9955(Whatsapp/Viber/iMessage/Ph#)

 suarezrochelle@yahoo.com

 AyalaLand PREMIER

PARK CENTRAL TOWERS

THE REST IS JUST LUXURY

NORTH TOWER
DIGITAL PRESENTATION MATERIAL

A DISTINCTIVE
RESIDENCE ELEVATES
ICONIC DESIGN AND A
SINGULAR ADDRESS WITH
THE KEY ELEMENTS OF
LUXURY – LOCATION,
SPACE, AND CHOICE



LUXURY OF LOCATION

A ROXAS TRIANGLE ADDRESS

- Located at the intersection of Makati Avenue and Paseo de Roxas, at the center of the “figure 8” or infinity symbol formed by Roxas and Ayala Triangles
- Central location provides uncompromised access to all urban conveniences
- Vicinity is home to the country’s most valuable residences

AYALA TRIANGLE REDEVELOPMENT

- Redevelopment includes a high-grade office building, Tower Two, Ayala Triangle Gardens, and a five-star hotel, Mandarin Oriental
- Will set stronger, integrated relationship between the two Triangles
- Increased allocation for retail, office, and hotel areas, which will culminate in 2020

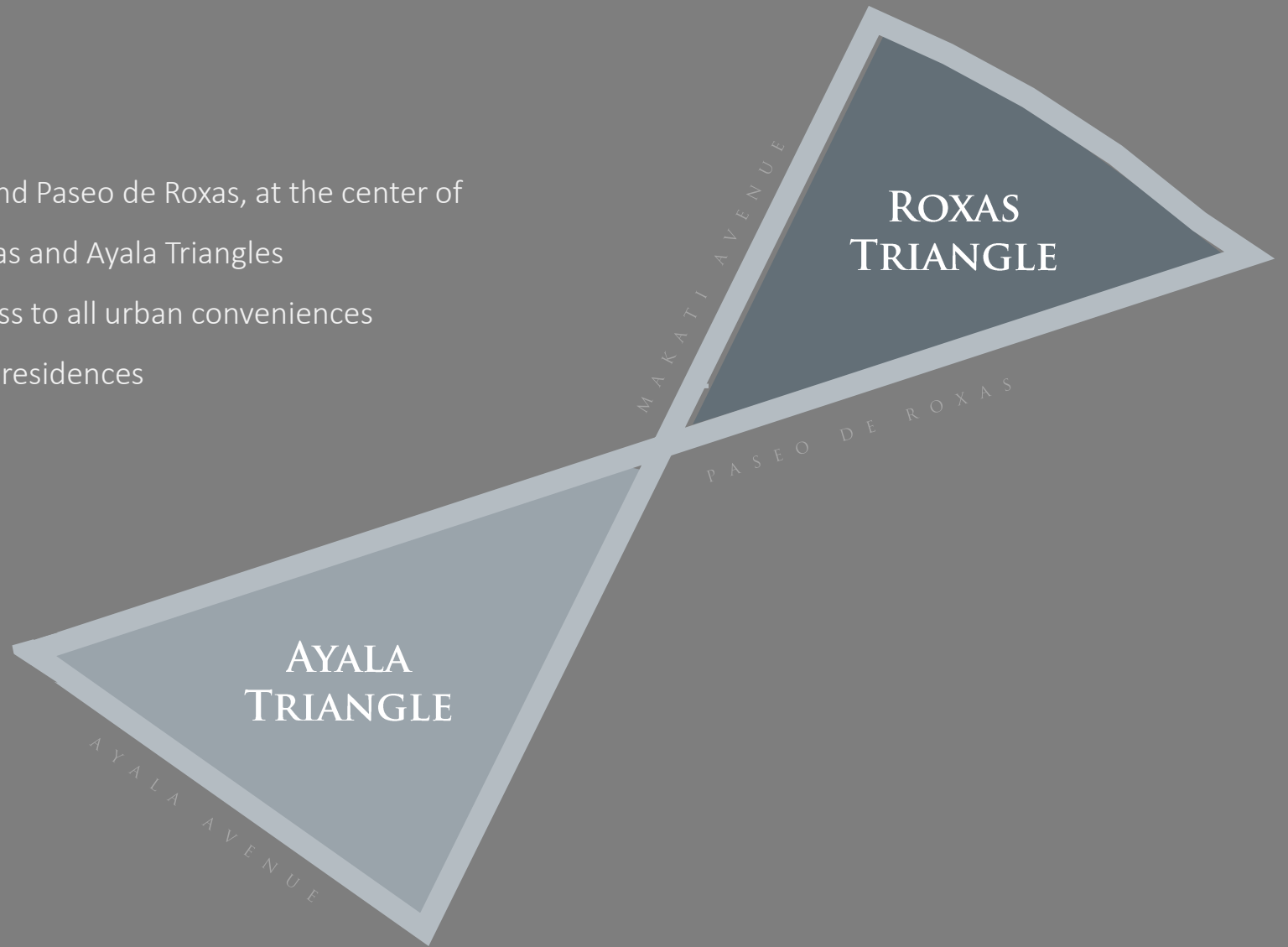

VICINITY MAP





ROXAS AND AYALA
TRIANGLES TODAY

Actual photograph

LUXURY OF LOCATION



ROXAS AND AYALA
TRIANGLES BY 2025

Artist's rendering

LUXURY OF LOCATION

AYALA TRIANGLE REDEVELOPMENT

TOWER TWO AYALA TRIANGLE GARDENS

Retail GLA: approx. 8,000 sqm
Office GLA: approx. 60,000 sqm

Supermarket
Cinemas
Modern food court concept
Specialty retail concepts
Restaurants facing the park
Wellness anchors
Convenience and basics
Services



Artist's rendering

LUXURY OF LOCATION

AYALA TRIANGLE REDEVELOPMENT

MANDARIN ORIENTAL HOTEL

5-star Hotel

22 floors

Connected to Ayala Tower Two
by a retail podium

Artist's rendering

LUXURY OF LOCATION

A CENTRAL LOCATION



Artist's rendering

LUXURY OF LOCATION

LUXURY OF SPACE

THE SITE'S SHEER SCALE

- Site covers a sprawling 15,860 (over 1.5 hectares) within Roxas Triangle
- Sheer scale allows for more open spaces around the building
- 50% of lot will remain open
- Residential towers' footprints take up only 25% of the entire lot – the rest of the lot is dedicated to open areas, amenities, and commercial establishments
- 3-storey retail podium with 10,300 sqm GLA
- Approximately 6,900 sqm dedicated to amenities and common areas across multiple levels of the building

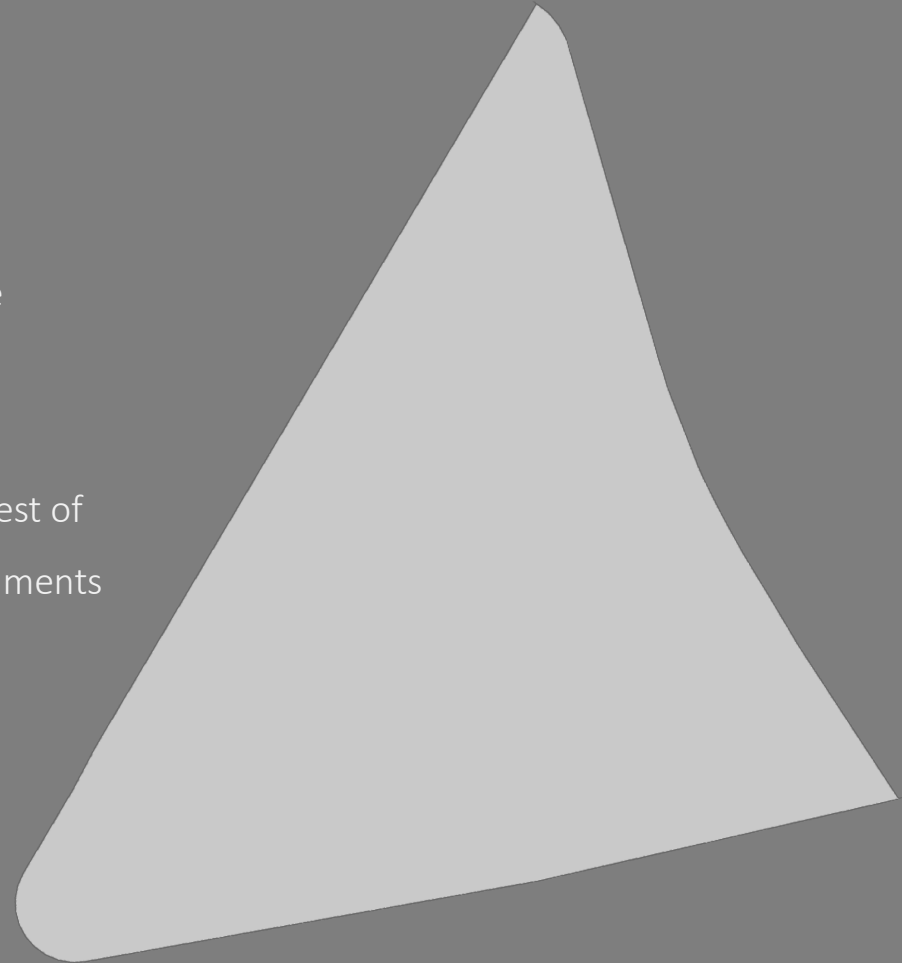

THE SITE

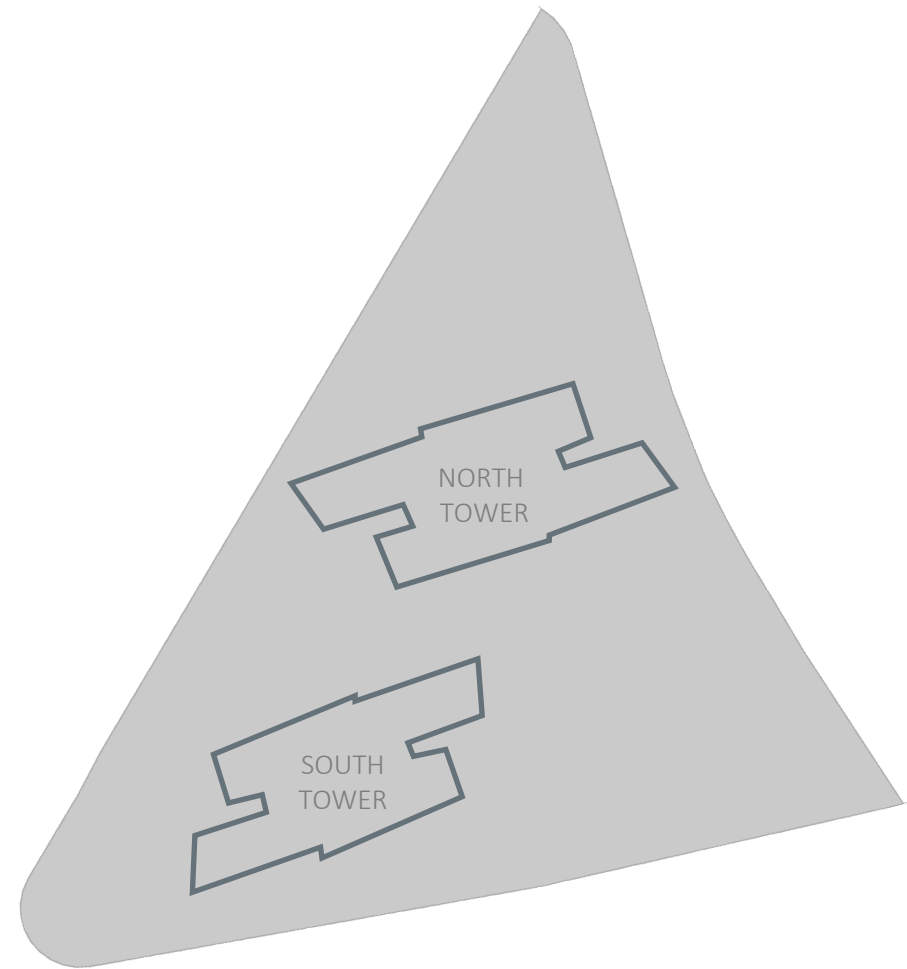

TOTAL AREA

Approx. 15,860 sqm

THE SITE

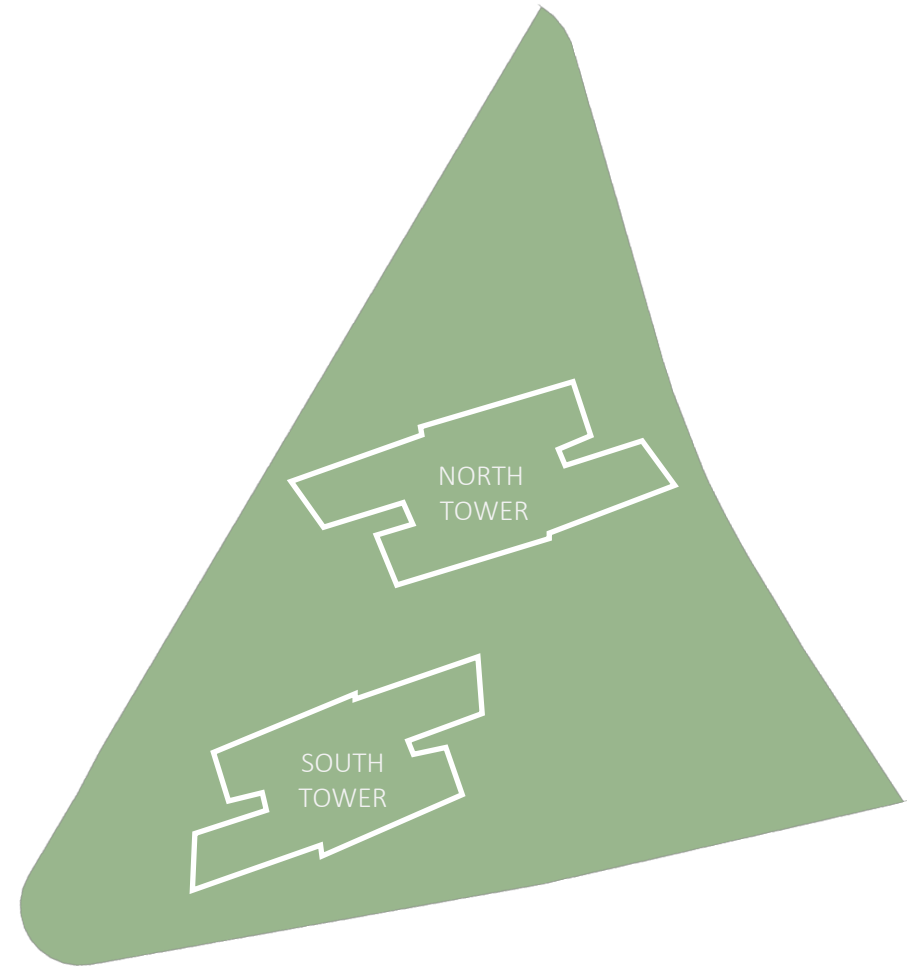

TOTAL AREA

Approx. 15,860 sqm

OPEN SPACE

Approx. 50% of lot

THE SITE

TYPICAL MAKATI COMMERCIAL LOT

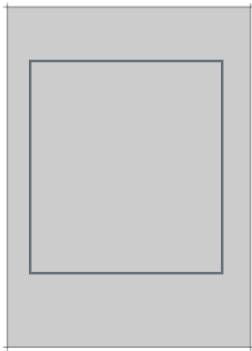

TOTAL AREA

Approx. 3,500 sqm

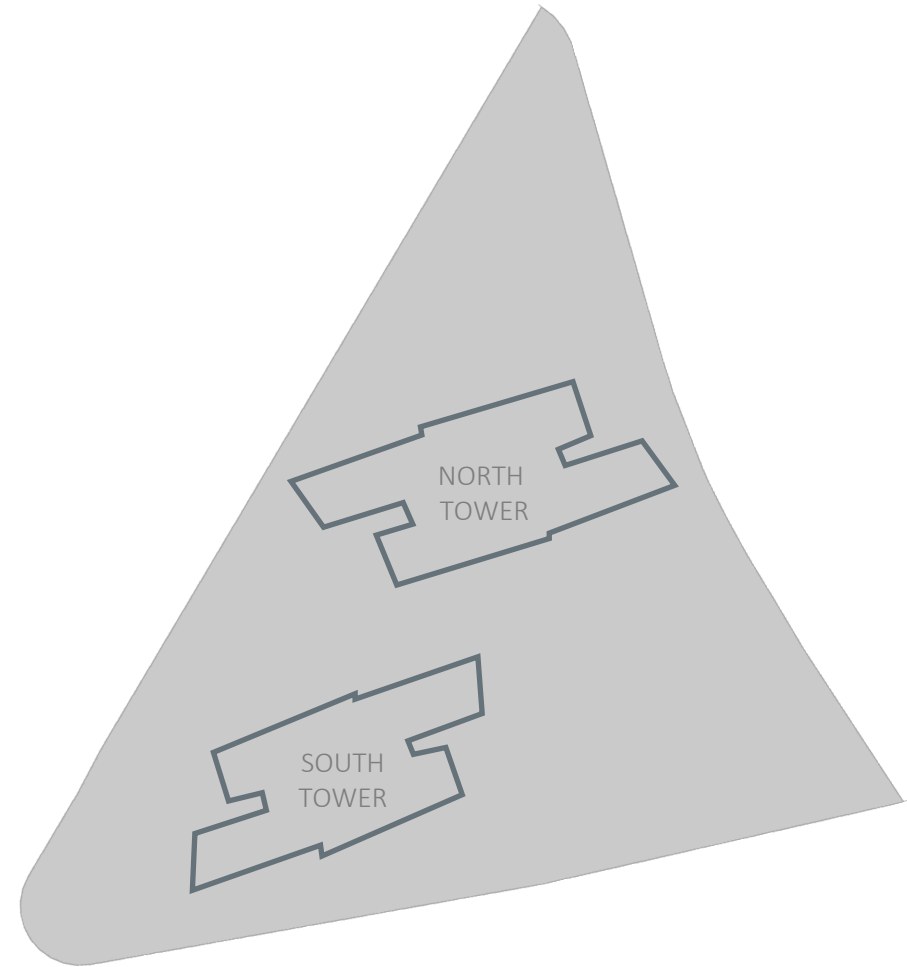

TOTAL AREA

Approx. 15,860 sqm

OPEN SPACE

Approx. 50% of lot

THE SITE

	SOUTH TOWER	NORTH TOWER
NUMBER OF UNITS	281	259
NUMBER OF FLOORS	69	56

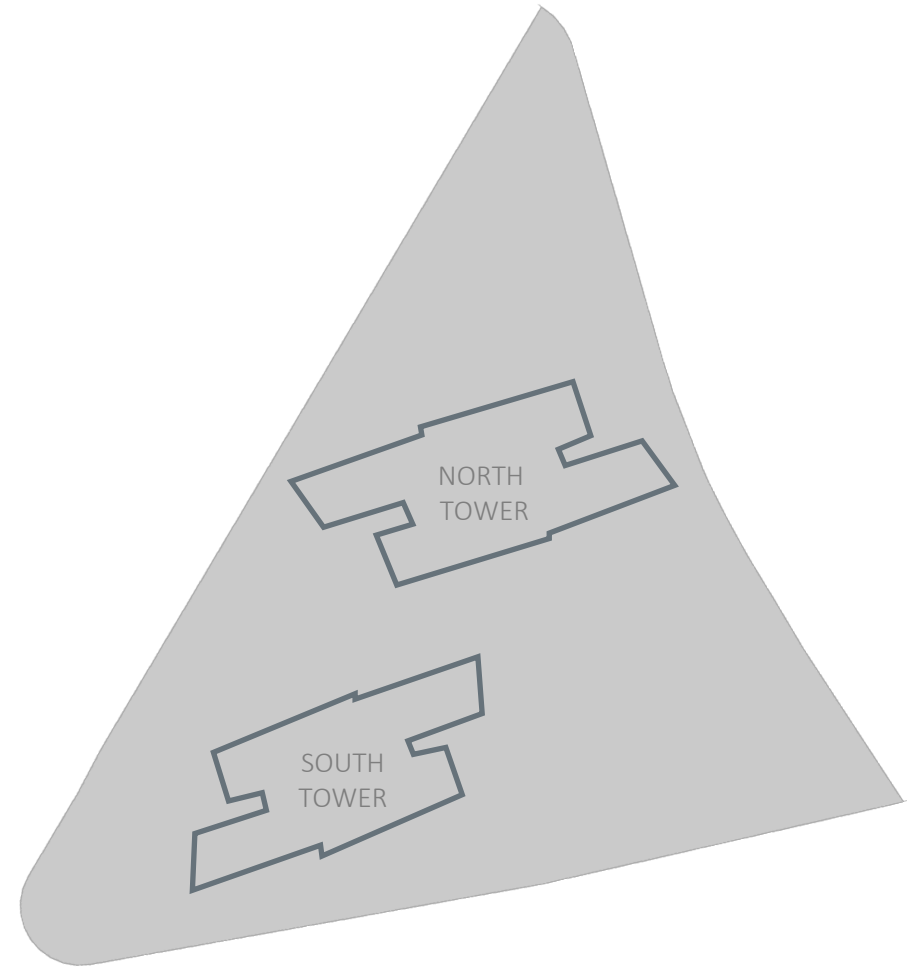

EXCEPTIONAL DESIGN

Building Features

Two residential towers anchored by a retail podium

Three storeys comprising retail, dining, and office establishments

Shared residential amenities at the third floor

Four Sky Terraces within each tower

Five basement levels of parking, with designated areas for
the residences and the retail podium

Residential motor court at the lower ground level

Retail motor court at ground level

Nine residential lifts per tower

- Four core lifts

- Four dedicated lifts

- One service lift

Three lifts for the retail podium

Special Features

Double-glazed, low-emissivity windows for all residences

- Buffers sound and intense heat from interior spaces, while allowing ideal levels of natural light to enter

Viscoelastic coupling damper (VCD) technology

- limits structure movement caused by extreme wind velocity, and reduces damage in the event of an earthquake



A MIXED-USE MASTERPLAN

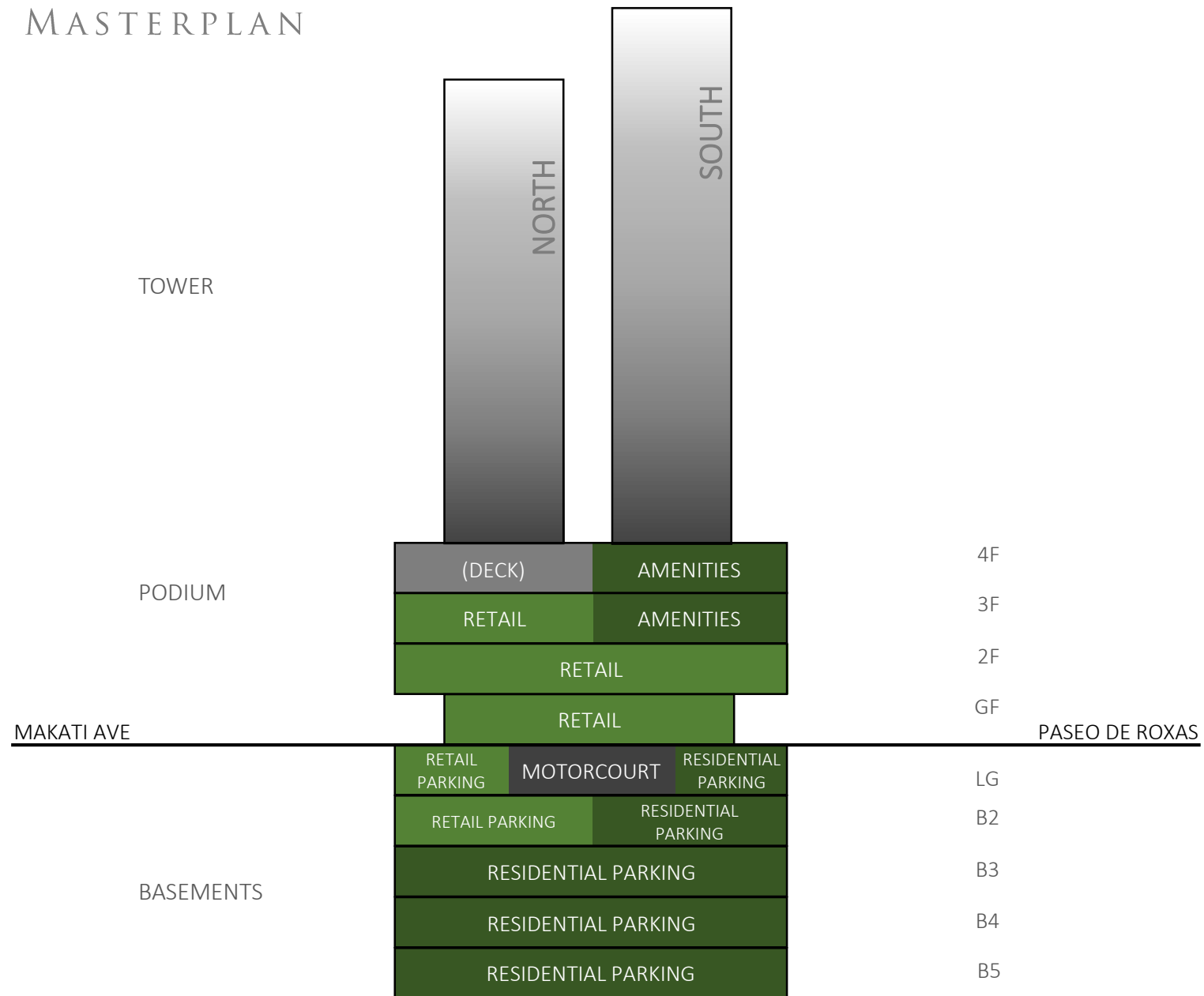

THREE LEVELS OF RETAIL AND OFFICE SPACES



GROUND LEVEL



SECOND FLOOR

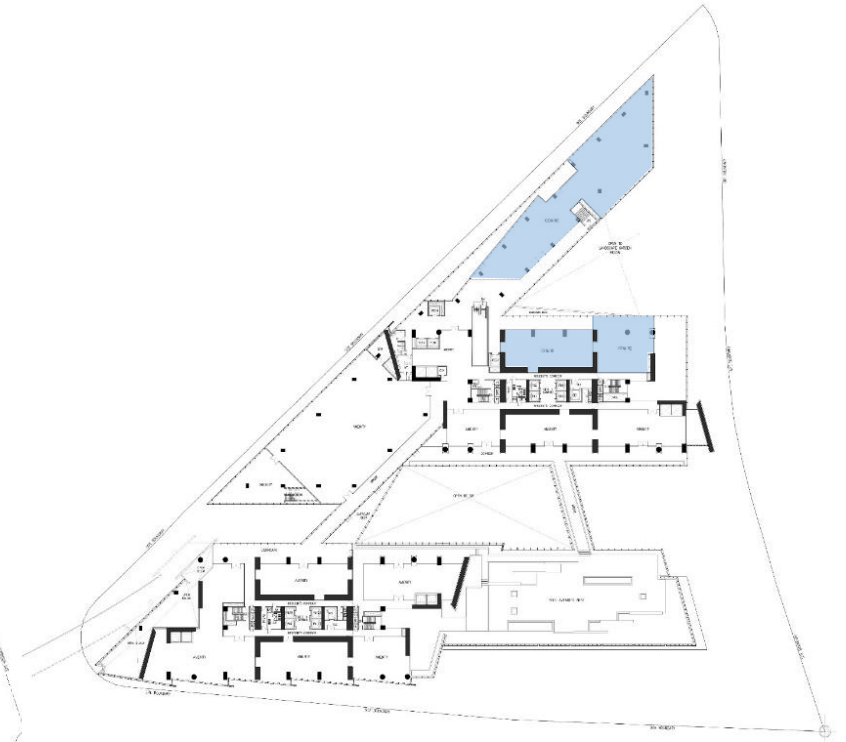

THIRD FLOOR

● SUPERMARKET

● RESTAURANT/CAFÉ

● OFFICE SPACE

● SPECIALTY SHOPS

Zoning indicates an initial mix only, reflecting the intended uses for the podium levels.

RETAIL PODIUM



Artist's rendering

LUXURY OF SPACE

RESIDENTIAL AMENITIES AT THE THIRD LEVEL

AMENITY	APPROX. AREA (SQM)
1 Multi-purpose Court	689
2 Bi-level Main Gym	346
3 Main Social Hall	157
4 Secondary Social Hall	123
5 Residents' Lounge	348
6 Game Room	195
7 Indoor Play Area	176
8 Main Pool	309
9 Kiddie Pool	54
10 Pool Deck & Landscaped Areas	989

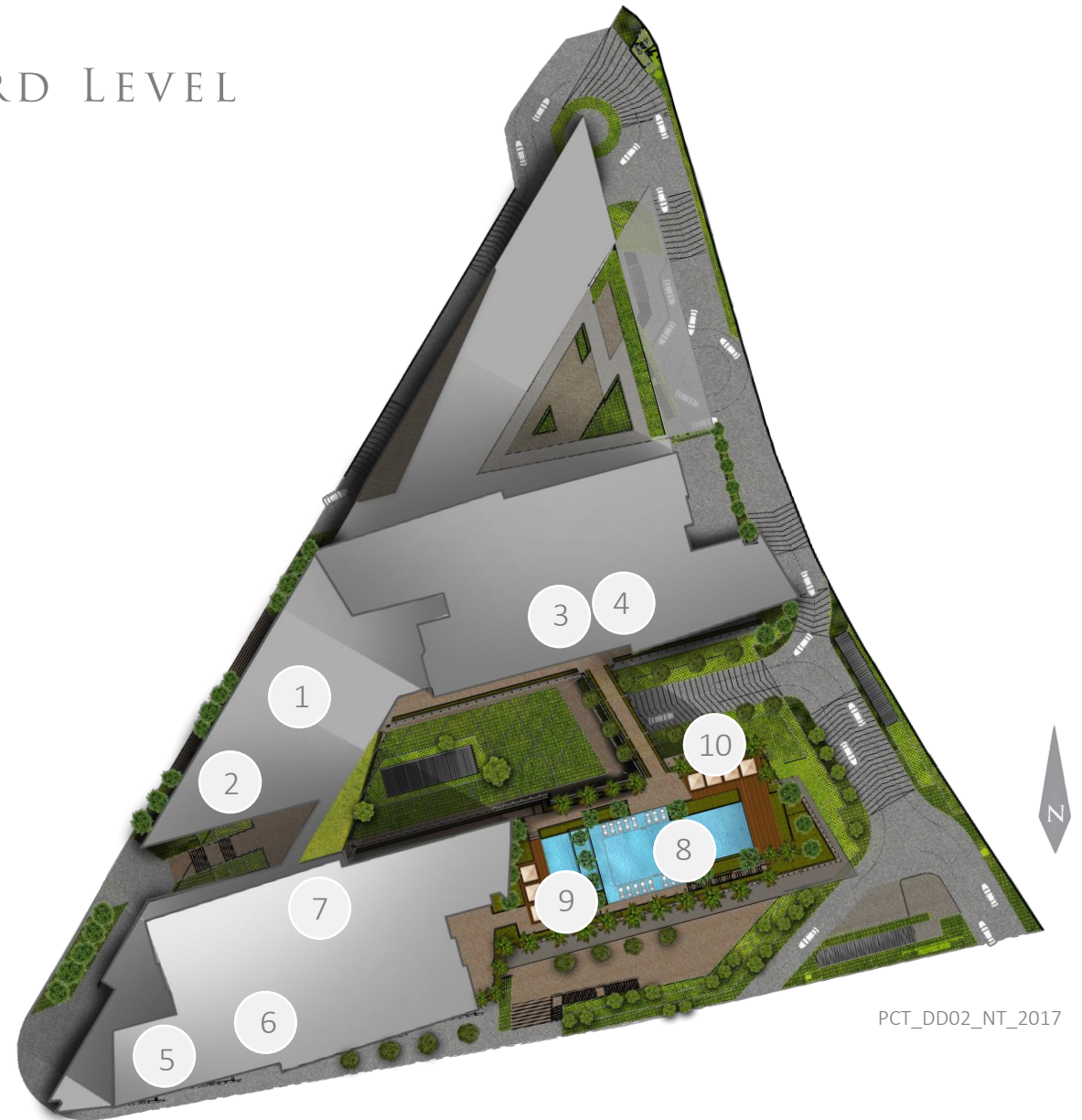

PCT_DD02_NT_2017

MULTI-PURPOSE COURT



Artist's rendering

LUXURY OF SPACE

RESIDENTS' LOUNGE



Artist's rendering

LUXURY OF SPACE

AMENITY DECK



Artist's rendering

LUXURY OF SPACE

SKY TERRACES NORTH TOWER

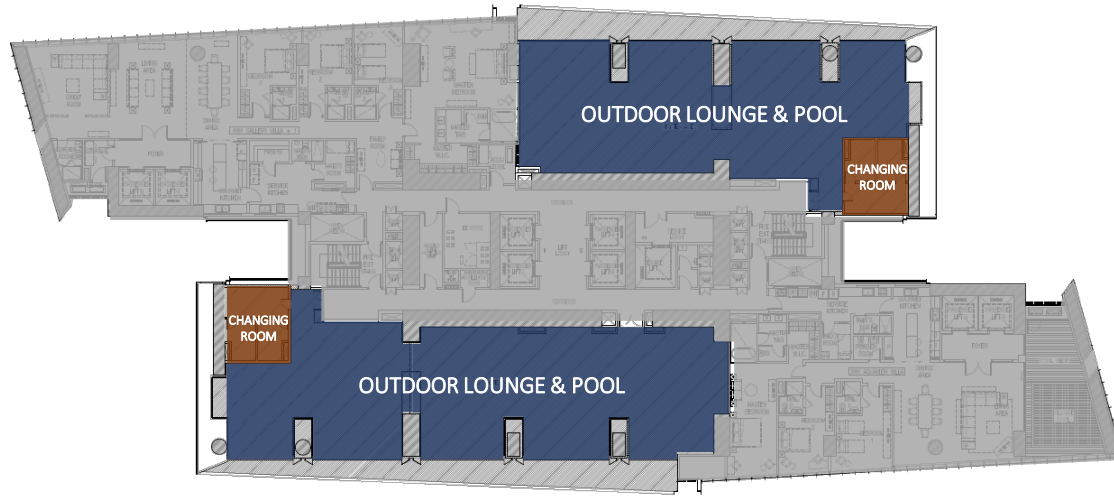

SKY TERRACE TWO 28TH FLOOR
Outdoor lounge and pool



SKY TERRACE ONE 16TH FLOOR
Fitness gym, studio and outdoor lounge

SKY TERRACE



Artist's rendering

LUXURY OF SPACE

PREMIER PARTNERS

ARCHITECT-OF-RECORD

Leandro V. Locsin and Partners

RETAIL INTERIOR ARCHITECT-OF-RECORD

Asuncion-Berenguer, Inc.

RESIDENTIAL INTERIOR ARCHITECT-OF-RECORD

J. Antonio Mendoza Design Consultants

LANDSCAPE DESIGN CONSULTANT

BCL Asia and Partners Co.

SPECIAL LIGHTING DESIGN CONSULTANT

C-LAO Philippines, Inc.

ACOUSTIC DESIGN CONSULTANT

K.G. Pua Acoustics Design & Consultancy

SECURITY CONSULTANT

Ace and Associates Risk Management, Inc.

ENGINEER-OF-RECORD

Sy² + Associates

MECHANICAL CONSULTANT

DCCD Engineering Corporation

SANITARY PLUMBING AND FIRE PROTECTION CONSULTANT

NBF Consulting, Inc.

LIFT CONSULTANT

Roy Barry & Associates

FAÇADE CONSULTANT

ALT Cladding, Inc.

QUANTITY SURVEYOR

Arcadis

PROJECT MANAGEMENT

Bureau Veritas

GENERAL CONTRACTOR

Makati Development Corporation

PROPERTY MANAGEMENT

Ayala Property Management Corporation



LUXURY OF CHOICE

LIVING FORMATS DESIGNED AROUND UNIQUE LIVING EXPERIENCES

- 14 different unit types are offered for Park Central North Tower, each with its own unique features
- 2-, 3-, and 4-bedroom residences are available, with select units having a flexible space which can be enclosed and converted to an additional room
- Meticulous space planning allows for more areas to be adjacent to the expansive windows
- Floor-to-ceiling, wall-to-wall windows allow natural light to stream in, and provide impressive views for the residents
- Distinctive features are available for select units
 - 47 boast double-height ceilings in certain areas
 - 90 are accessed through semi-private lifts which open up directly to the unit's own lift lobby
 - 23 feature their own plunge pool and deck

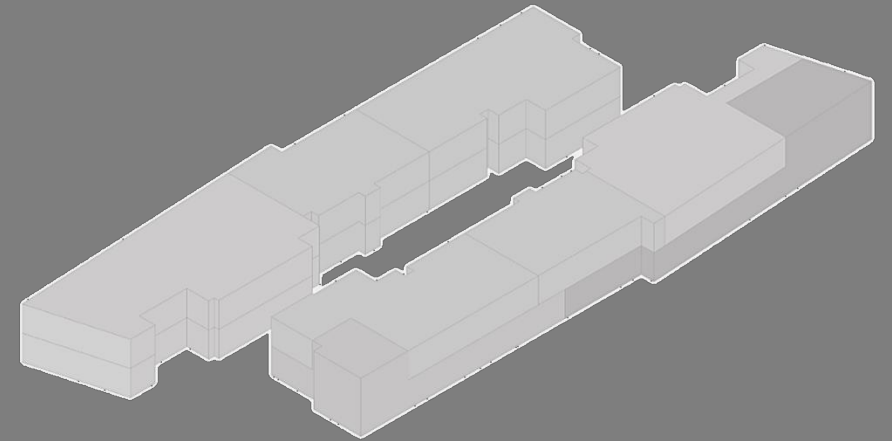

NORTH TOWER RESIDENTIAL ZONING

SKY TERRACE TWO FLOORS
28TH – 31ST

SKY TERRACE ONE FLOORS
16TH – 19TH

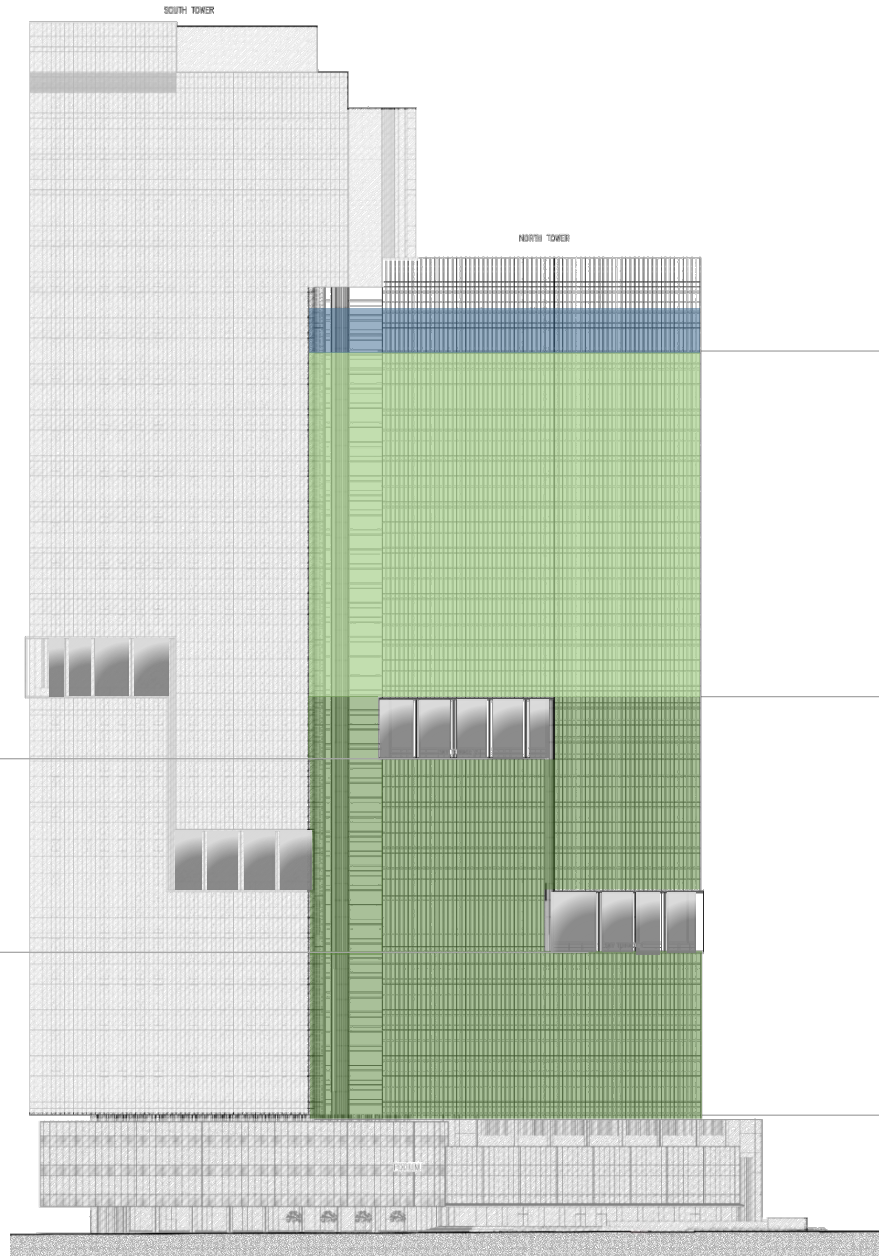

ANADEM FLOORS 55TH – 56TH

HIGH ZONE 32ND – 54TH

MID ZONE 5TH – 31ST

RETAIL PODIUM GF – 4TH

NORTH TOWER MID ZONE FLOOR PLATES



UPPER FLOOR PLATE 6th, 8th, 10th, 12th, 15th, 21st, 23rd, 25th, 27th



LOWER FLOOR PLATE 5th, 7th, 9th, 11th, 14th, 20th, 22nd, 24th, 26th

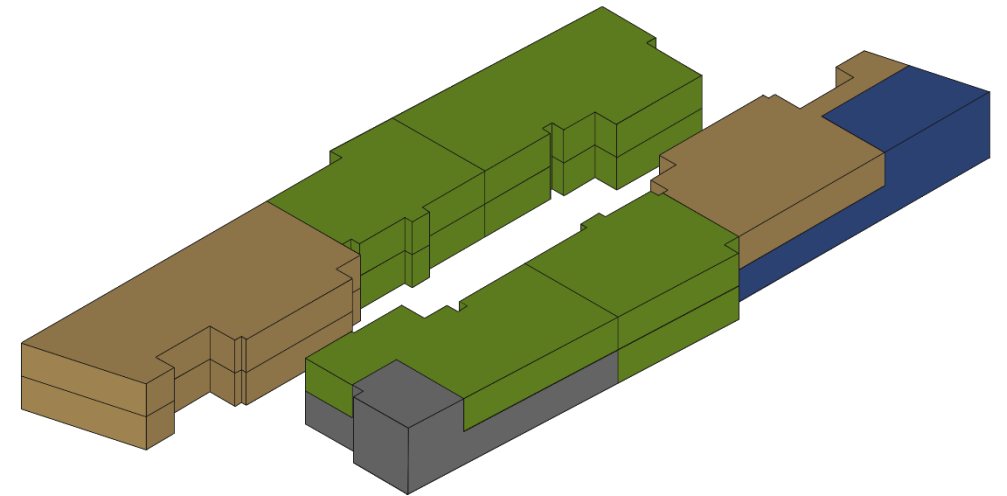

- Glass Suite
- Gallery Villa
- Skyview Villa
- Aquaview Villa

NORTH TOWER HIGH ZONE FLOOR PLATES



UPPER FLOOR PLATE 33rd, 35th, 37th, 39th, 41st, 43rd, 46th, 48th, 50th, 52nd, 54th



LOWER FLOOR PLATE 32nd, 34th, 36th, 38th, 40th, 42nd, 45th, 47th, 49th, 51st, 53rd

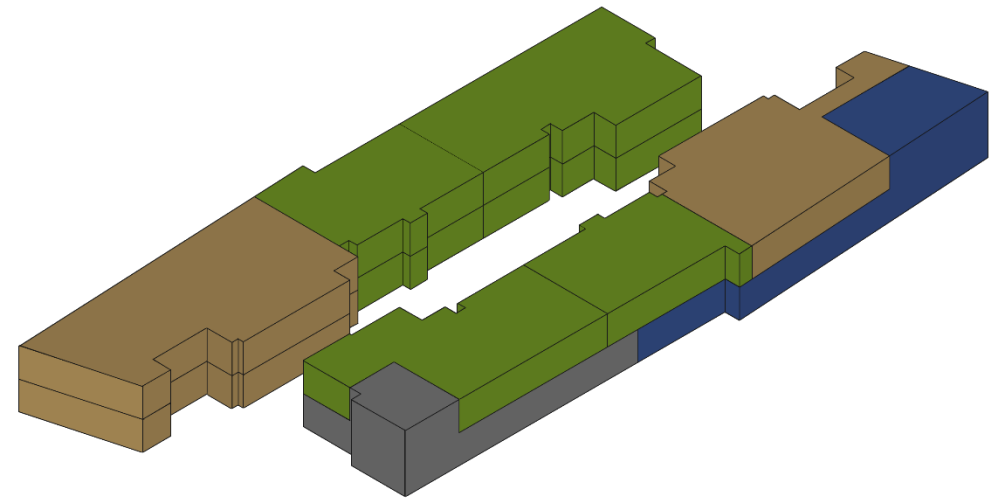

- Glass Suite
- Skyview Villa
- Gallery Villa
- Aquaview Villa

NORTH TOWER ANADEM FLOOR PLATES

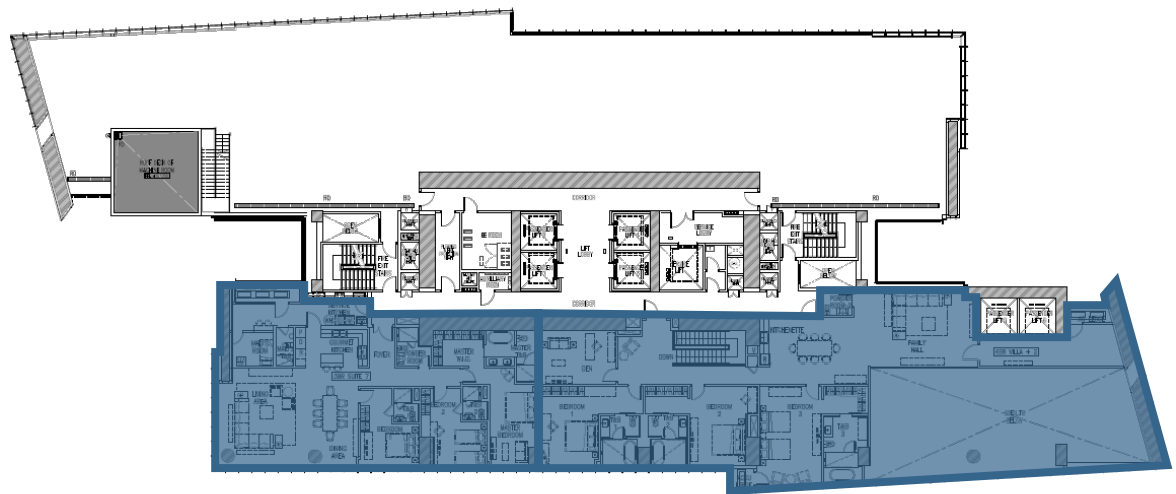

UPPER FLOOR PLATE 56th

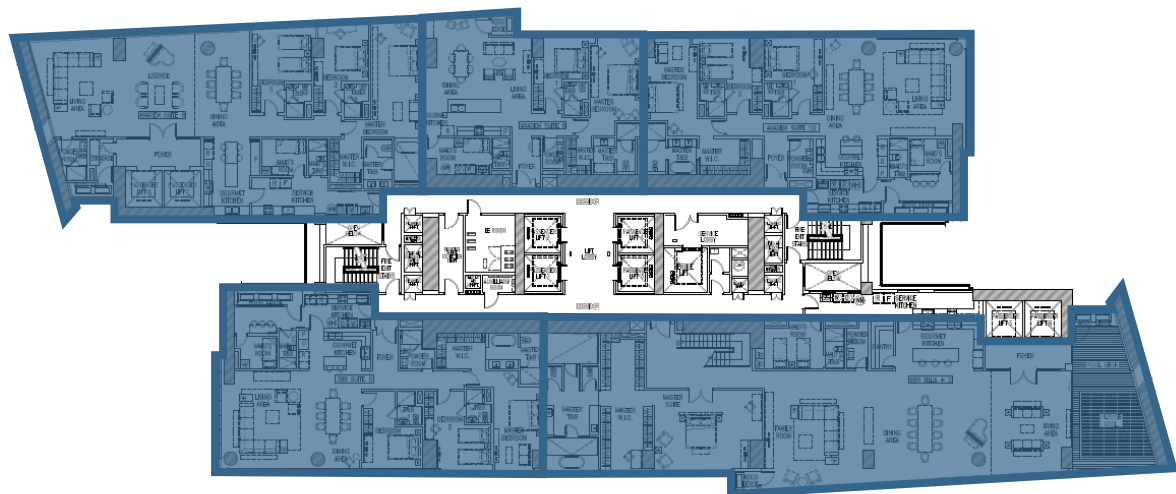

LOWER FLOOR PLATE 55th

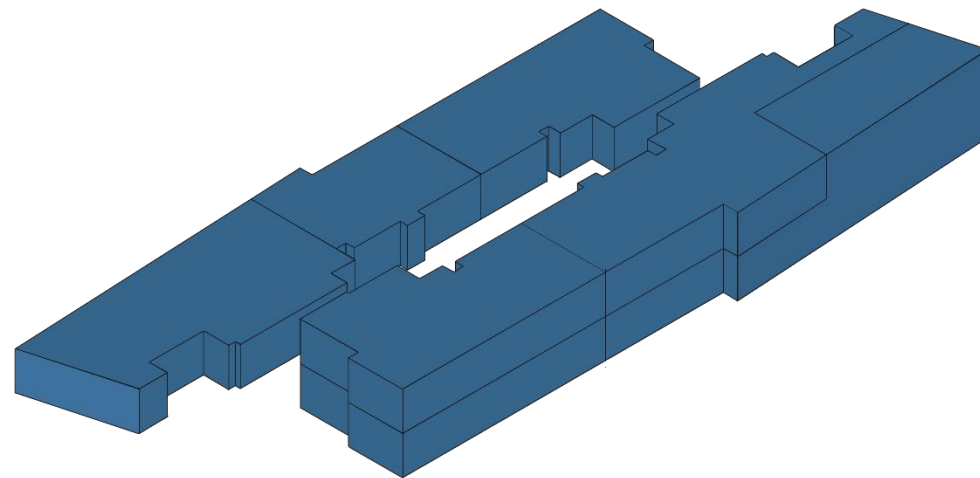

NORTH TOWER
STACKED FLOOR PLATES

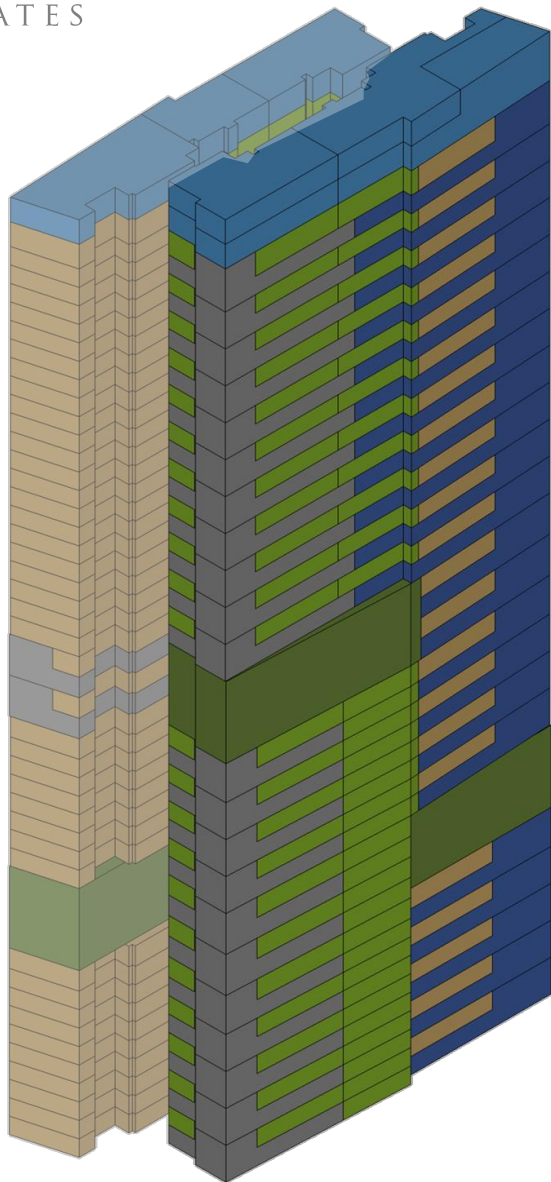

FACING URDANETA

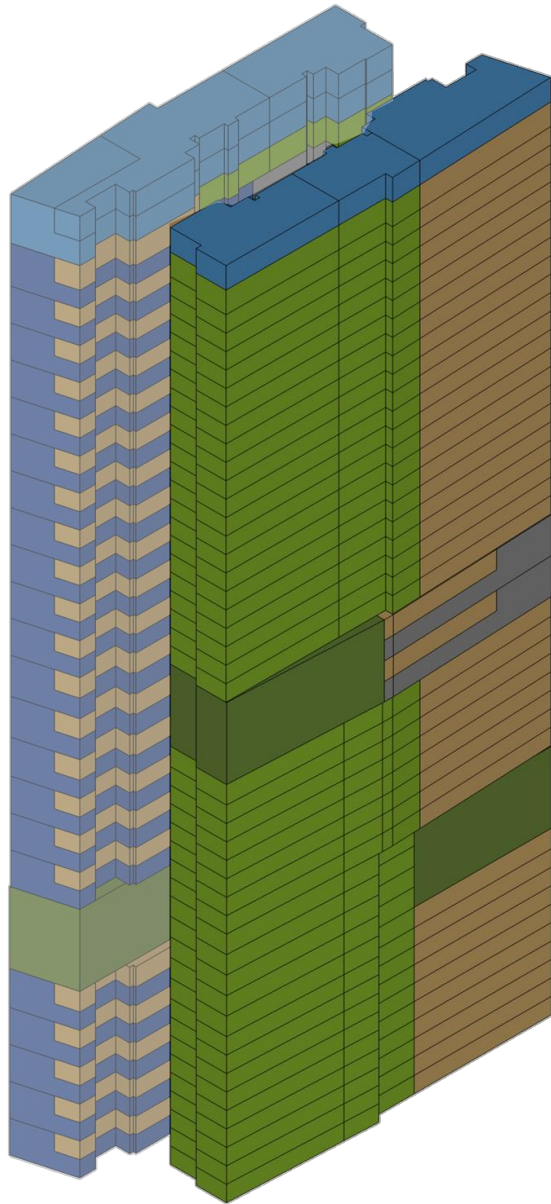

FACING MAKATI

LUXURY OF CHOICE

VIEWS FROM THE SITE



VIEWS FROM THE SITE



VIEWS FROM THE SITE



VIEWS FROM THE SITE



UNIT LAYOUTS

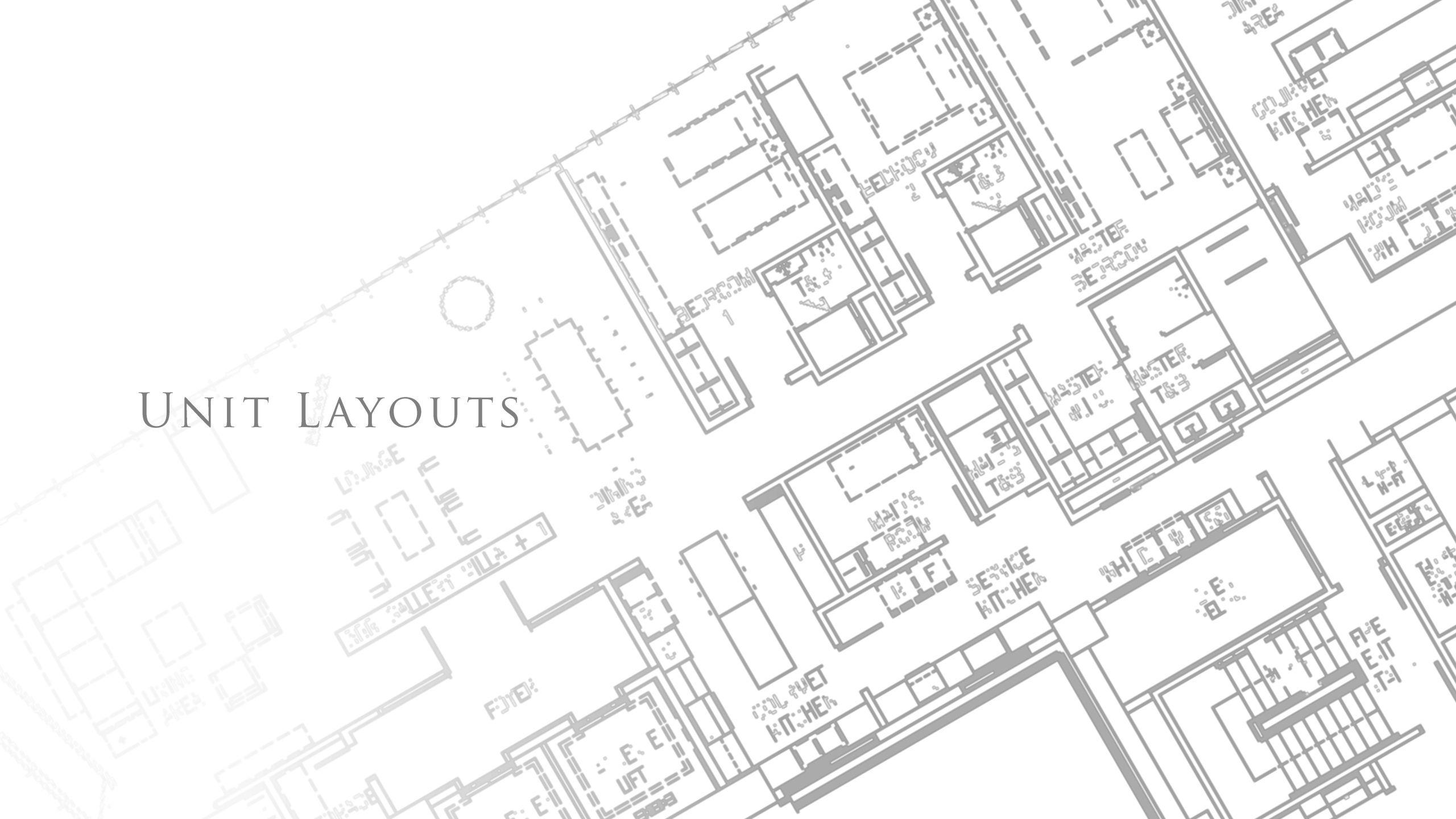

UNIT MIX

GLASS SUITES

UNIT TYPES	NUMBER OF UNITS	APPROX. AREA RANGE	
		SQM	SQFT
Two-Bedroom Glass Suite (Makati)	44	146 - 161	1,507 - 1,733
Two-Bedroom Glass Suite (Urdaneta)	33	139 - 158	1,496 - 1,701
Two-Bedroom Glass Suite Plus	22	188 - 197	2,024 - 2,120
Three-Bedroom Glass Suite Corner	44	233 - 245	2,508 - 2,648

GALLERY VILLAS

UNIT TYPES	NUMBER OF UNITS	APPROX. AREA RANGE	
		SQM	SQFT
Two-Bedroom Gallery Villa	22	210 - 226	2,260 - 2,433
Three-Bedroom Gallery Villa	2	307	3,305
Three-Bedroom Gallery Villa Plus	40	286 - 301	3,078 - 3,240

SKYVIEW VILLAS

UNIT TYPES	NUMBER OF UNITS	APPROX. AREA RANGE	
		SQM	SQFT
Three-Bedroom Skyview Villa	11	241 - 266	2,594 - 2,863
Three-Bedroom Skyview Villa Plus	11	265 - 266	2,852 - 2,863
Four-Bedroom Skyview Villa Plus	2	384	4,133

AQUAVIEW VILLAS

UNIT TYPES	NUMBER OF UNITS	APPROX. AREA RANGE	
		SQM	SQFT
Three-Bedroom Aquaview Villa	11	286 - 304	3,078 - 3,272
Four-Bedroom Aquaview Villa	11	410 - 413	4,413 - 4,446

ANADEM COLLECTION

UNIT TYPES	NUMBER OF UNITS	APPROX. AREA RANGE	
		SQM	SQFT
Anadem Suite Six and Seven	2	234 - 235	2,519 - 2,530
Anadem Suite Eight	1	299	3,218
Anadem Suite Nine	1	151	1,625
Anadem Suite Ten	1	236	2,540
Anadem Villa Two	1	753	8,105

TOTAL 259

TWO-BEDROOM GLASS SUITE
(MAKATI VIEW)

44 UNITS

APPROXIMATE AREA SIZE

146 – 161 sqm

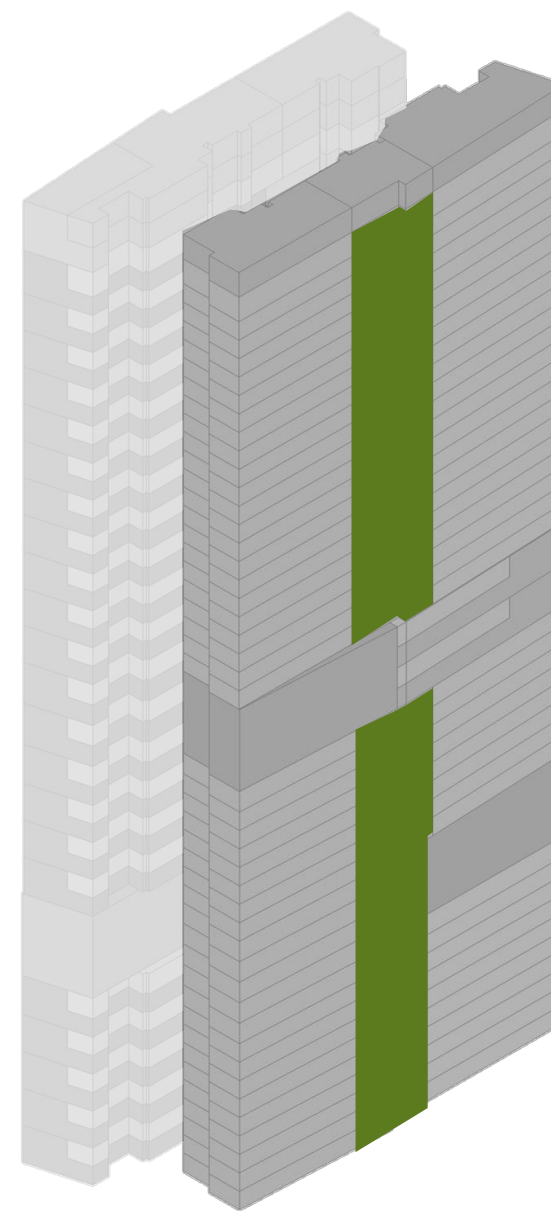

FACING MAKATI

TWO-BEDROOM GLASS SUITE (MAKATI VIEW)

44 UNITS

APPROXIMATE AREA SIZE

146 – 161 sqm

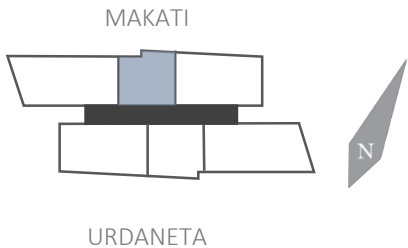
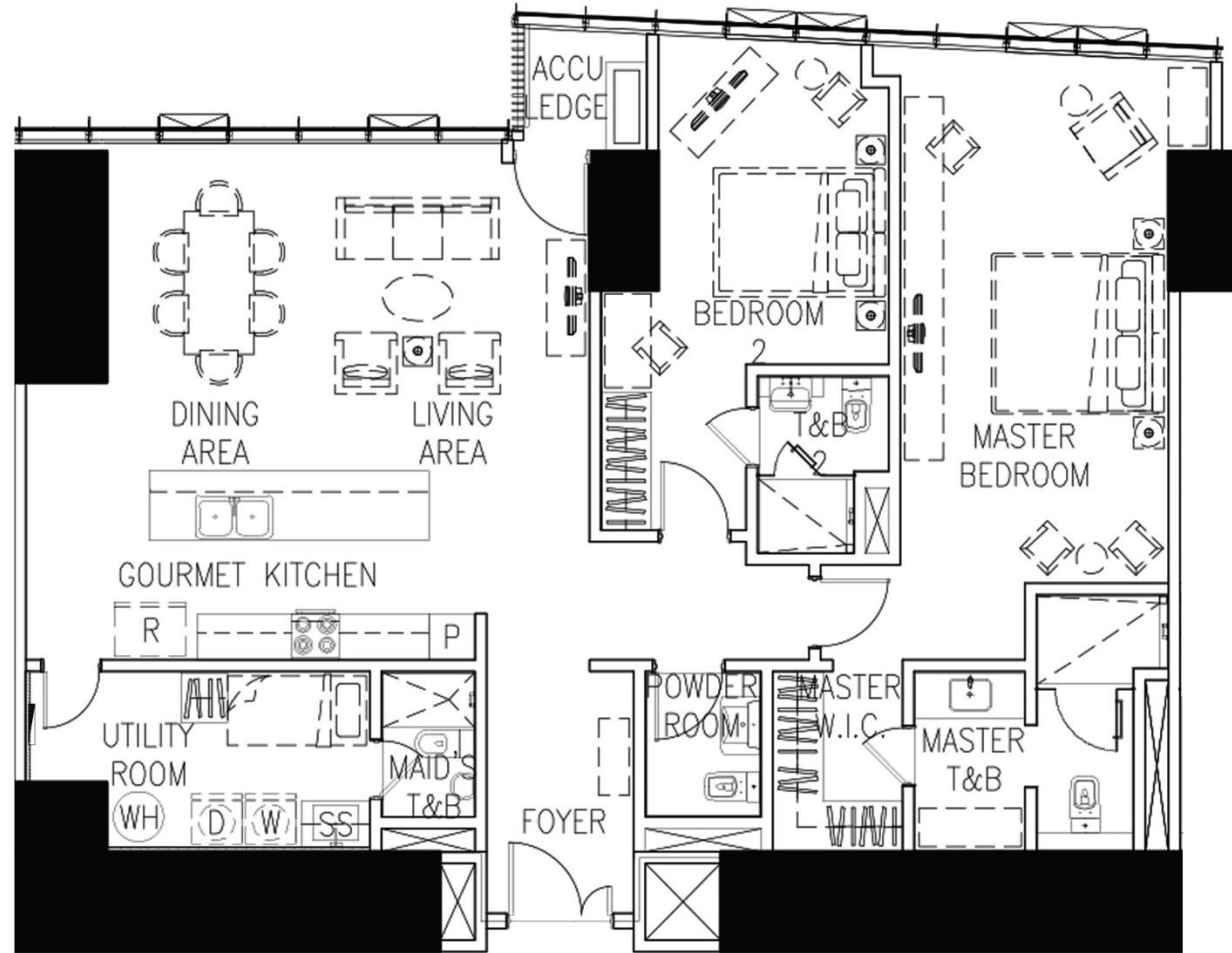

TWO-BEDROOM GLASS SUITE

EXTERIOR PERSPECTIVE OF THE LIVING AND DINING AREAS AND A BEDROOM



TWO-BEDROOM GLASS SUITE
(URDANETA VIEW)

33 UNITS

APPROXIMATE AREA SIZE

139 – 158 sqm

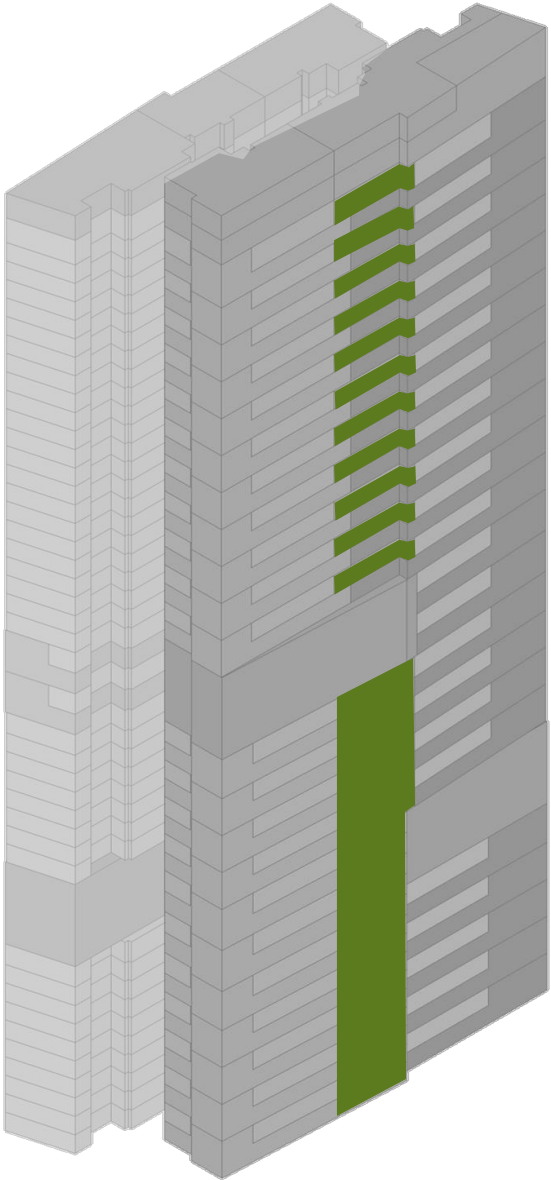

FACING URDANETA

TWO-BEDROOM GLASS SUITE (URDANETA VIEW)

33 UNITS

APPROXIMATE AREA SIZE

139 – 158 sqm

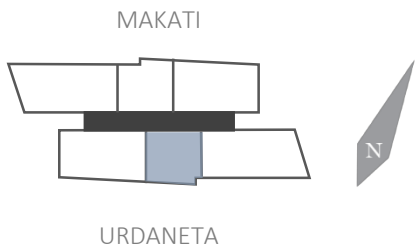
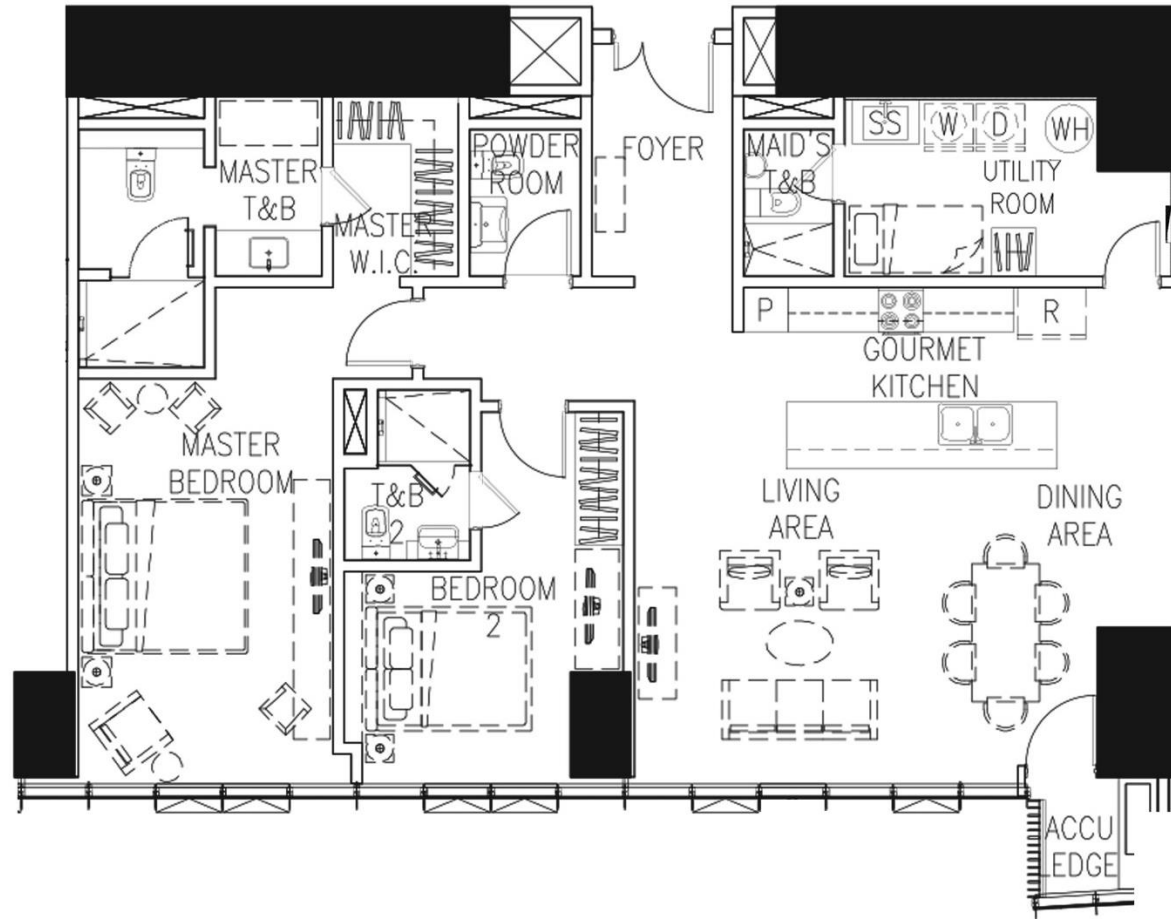

TWO-BEDROOM GLASS SUITE PLUS

22 UNITS

APPROXIMATE AREA RANGE

188 – 197 sqm

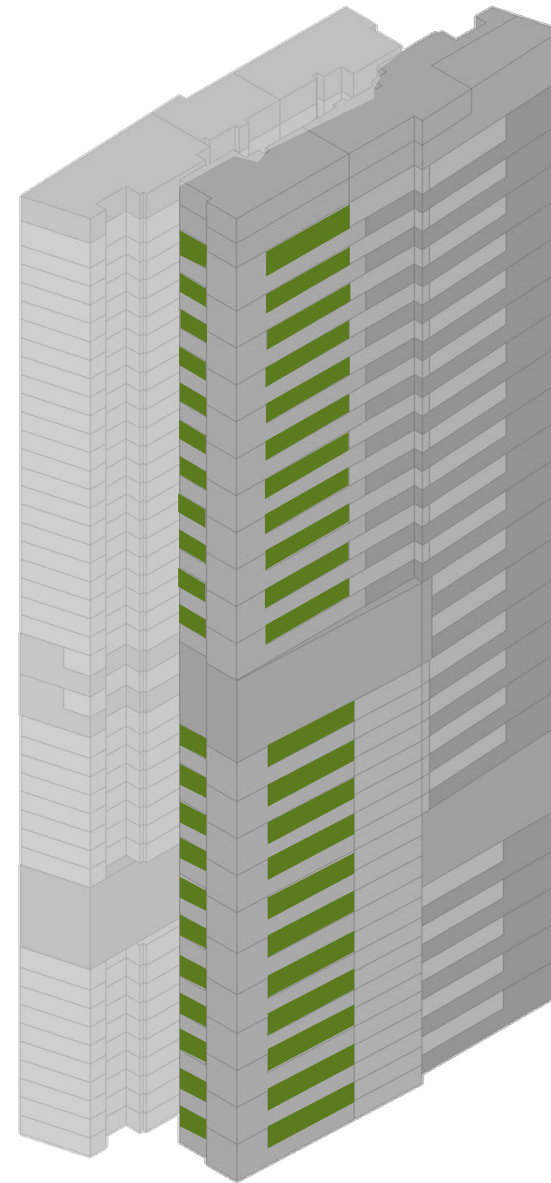

FACING URDANETA

TWO-BEDROOM GLASS SUITE PLUS

22 UNITS

APPROXIMATE AREA RANGE

188 – 197 sqm

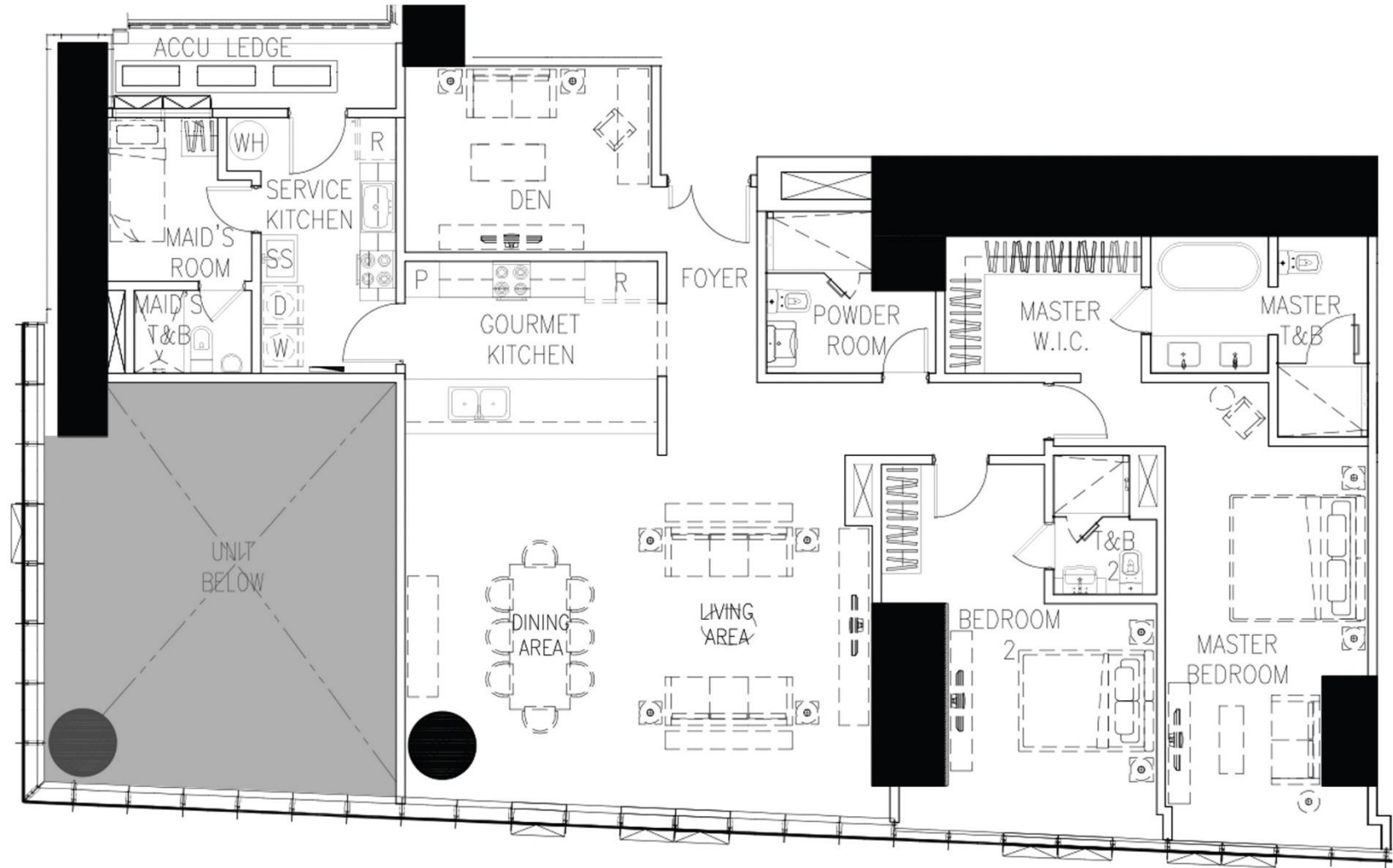

MAKATI

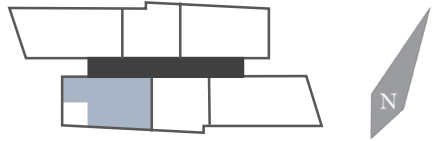

URDANETA

THREE-BEDROOM GLASS SUITE CORNER

44 UNITS

APPROXIMATE AREA RANGE

233 – 245 sqm

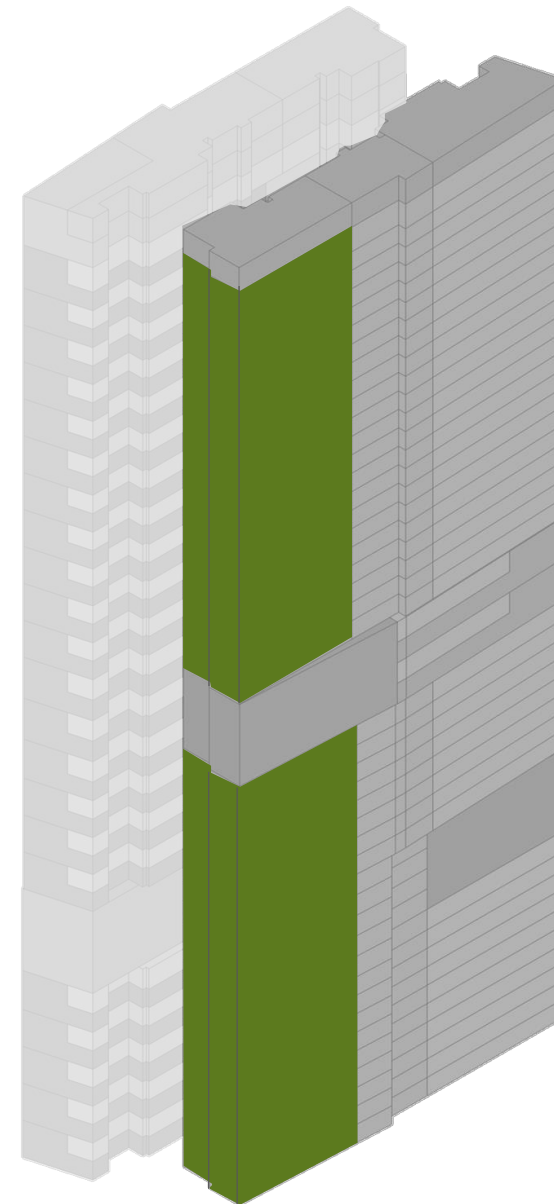

FACING MAKATI

THREE-BEDROOM GLASS SUITE CORNER

44 UNITS

APPROXIMATE AREA RANGE

233 – 245 sqm

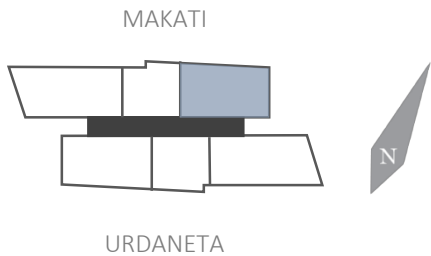
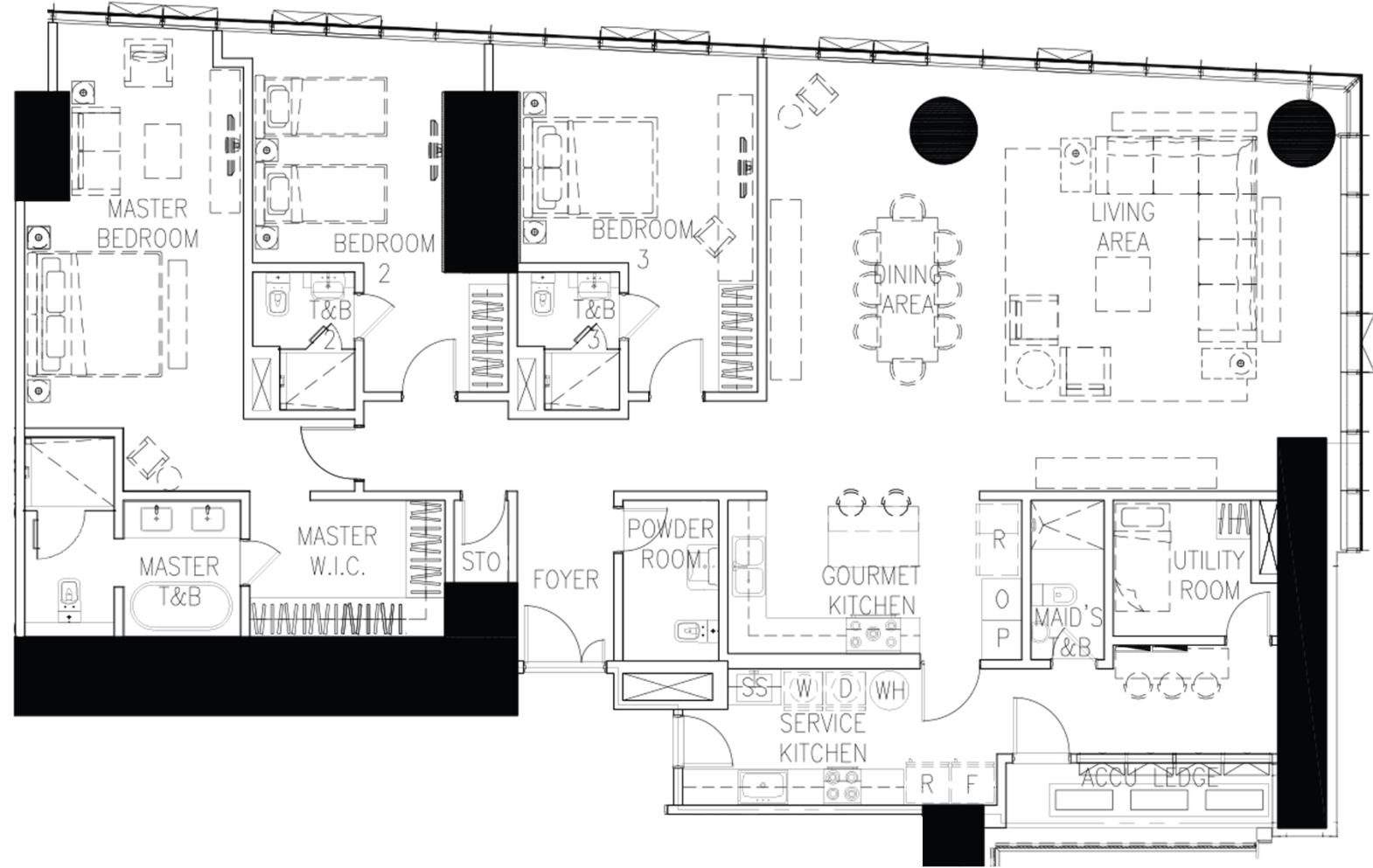

THREE-BEDROOM GLASS SUITE CORNER
LIVING AND DINING AREAS



TWO-BEDROOM GALLERY VILLA

22 UNITS

APPROXIMATE AREA RANGE

210 – 226 sqm

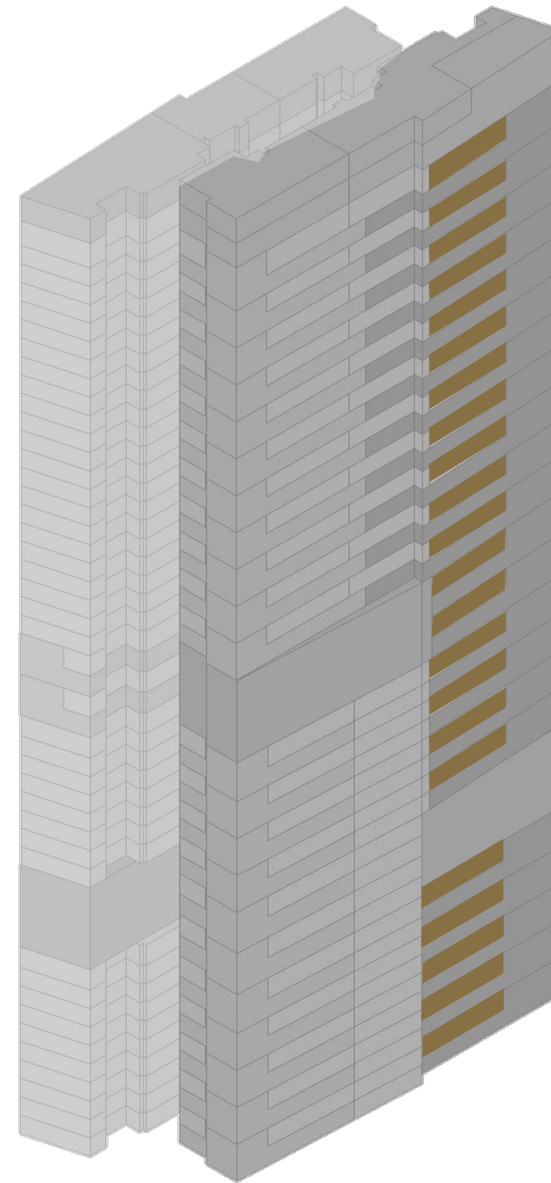

FACING URDANETA

TWO-BEDROOM GALLERY VILLA

22 UNITS

APPROXIMATE AREA RANGE

210 – 226 sqm

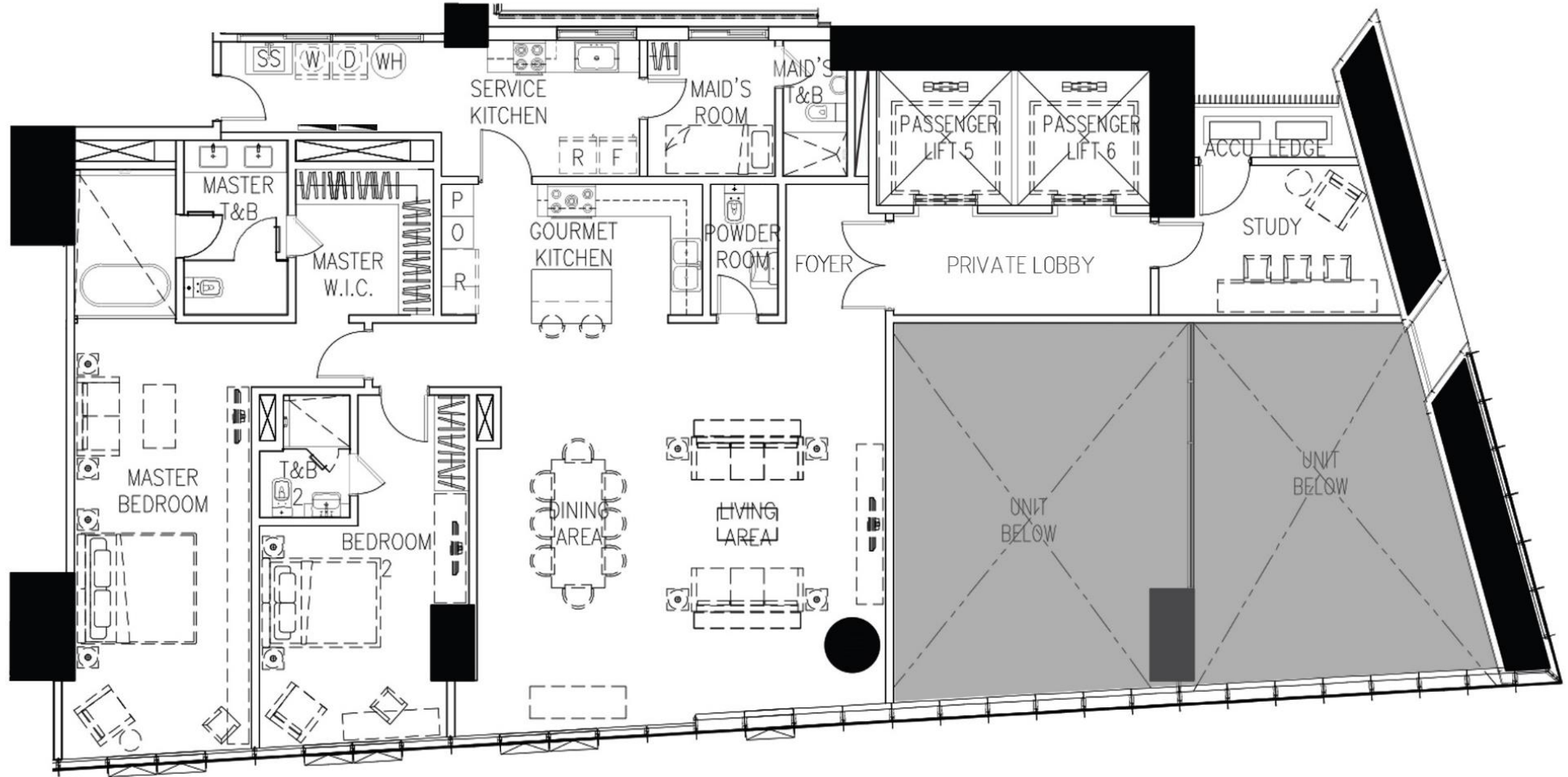

MAKATI



URDANETA

TWO-BEDROOM GALLERY VILLA
LIVING AND DINING AREAS, GOURMET KITCHEN



THREE-BEDROOM GALLERY VILLA

2 UNITS

APPROXIMATE AREA

307 SQM

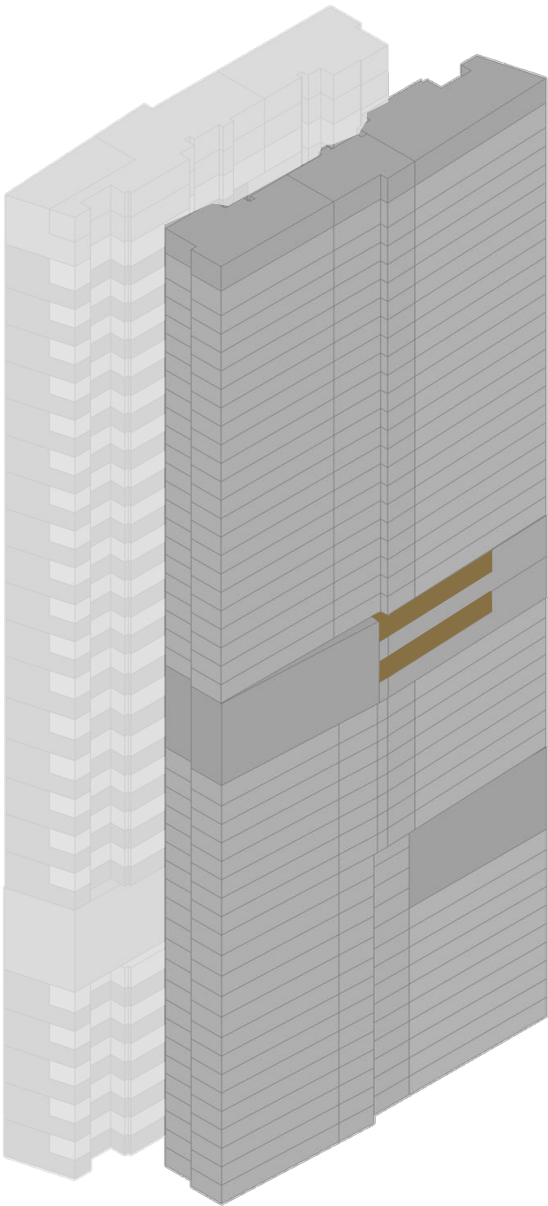

FACING MAKATI

THREE-BEDROOM GALLERY VILLA

2 UNITS

APPROXIMATE AREA

307 SQM

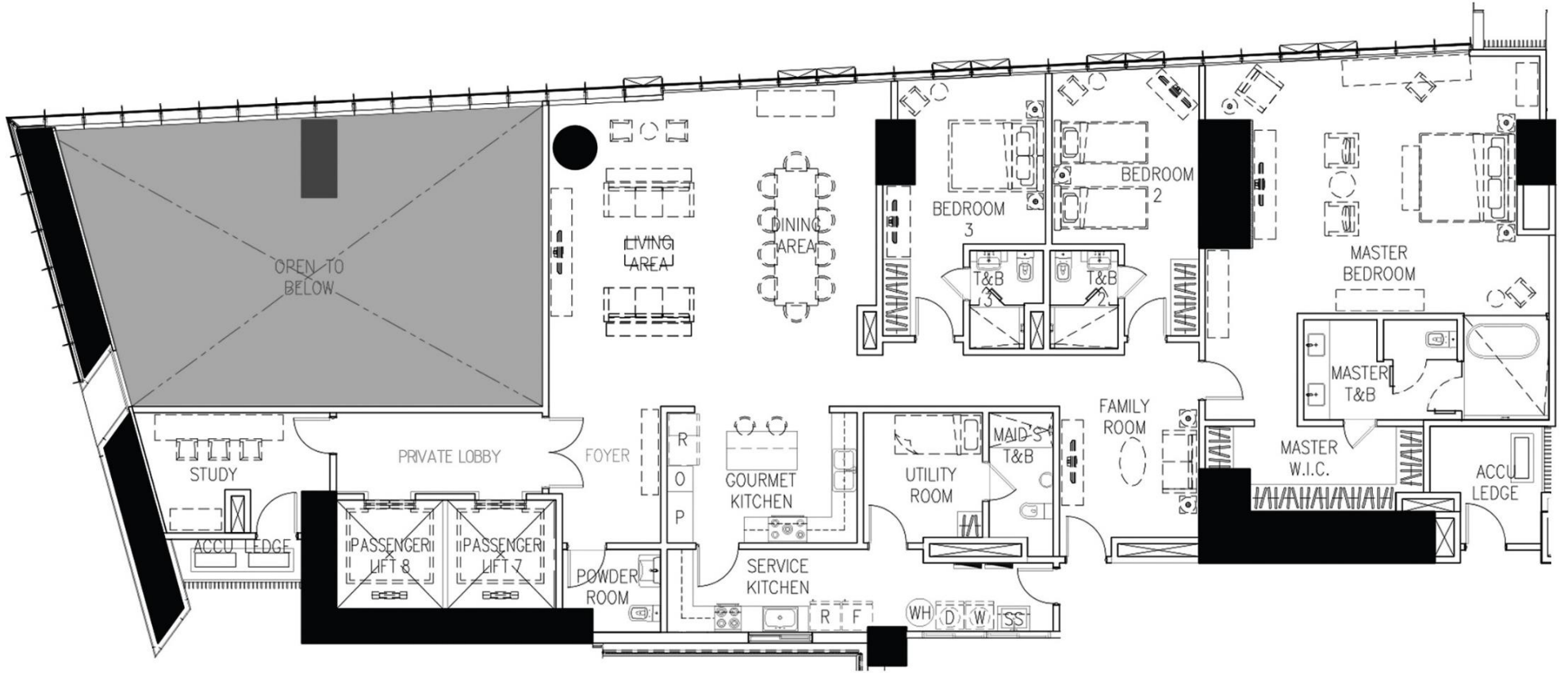

MAKATI

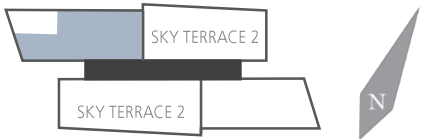

URDANETA

THREE-BEDROOM GALLERY VILLA
MASTER BEDROOM



THREE-BEDROOM GALLERY VILLA PLUS

40 UNITS

APPROXIMATE AREA RANGE

286 – 301 sqm

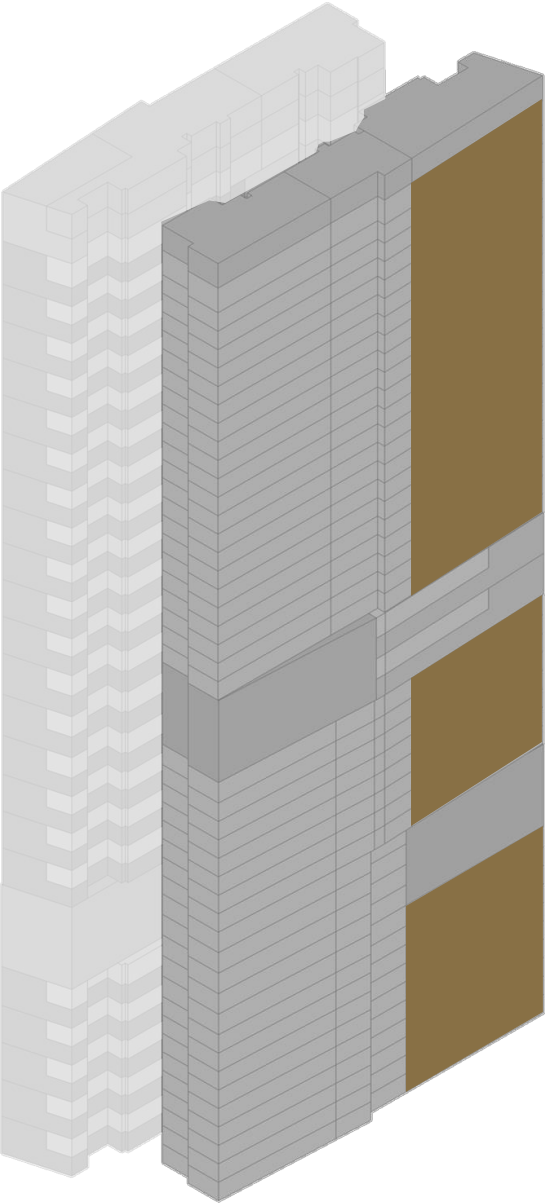

FACING MAKATI

THREE-BEDROOM GALLERY VILLA PLUS

40 UNITS

APPROXIMATE AREA RANGE

286 – 301 sqm

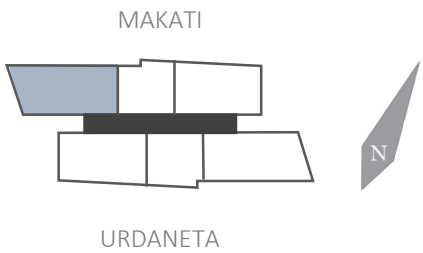
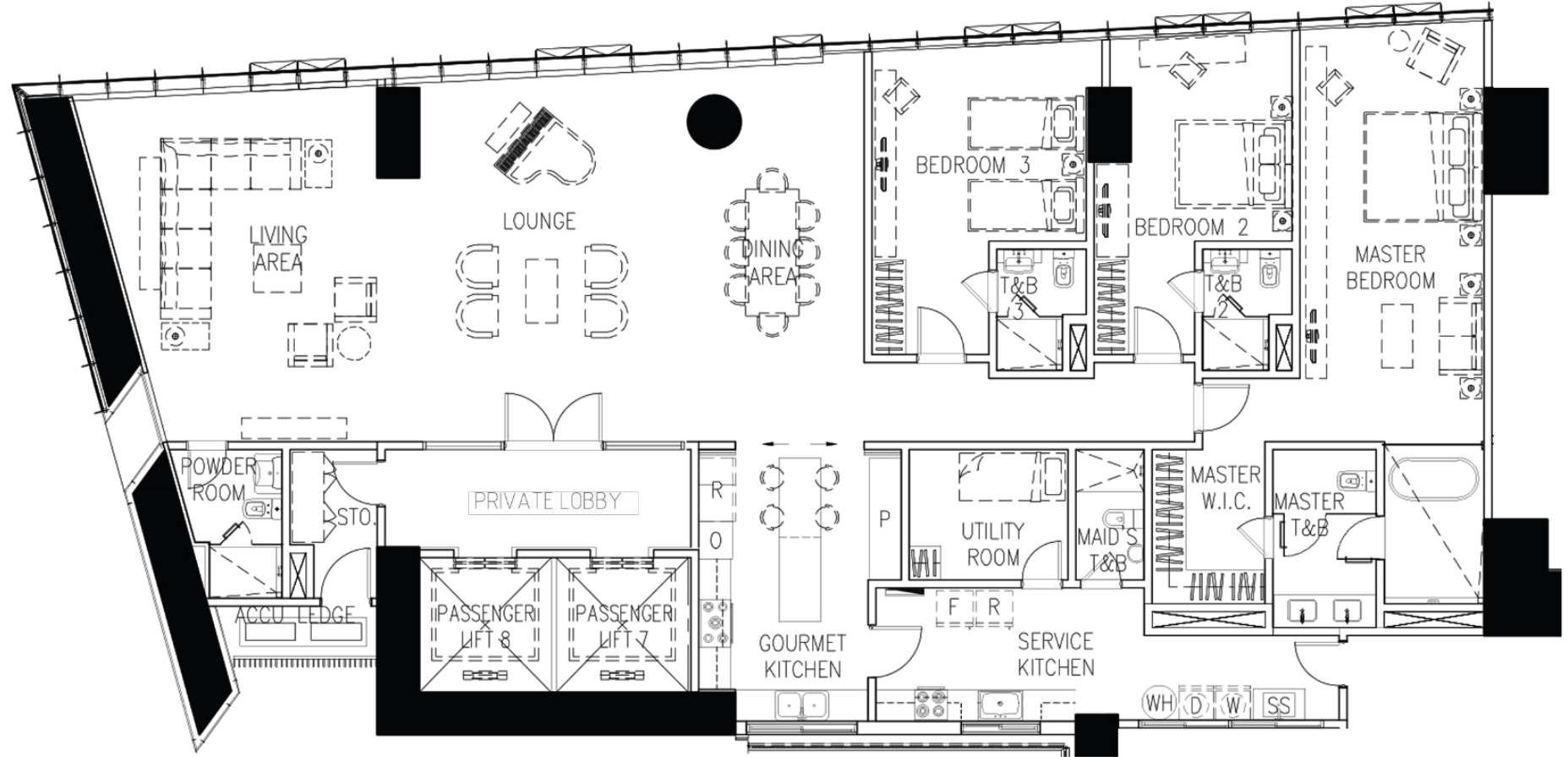

THREE-BEDROOM GALLERY VILLA PLUS
PRIVATE LIFT LOBBY, LIVING AND DINING AREAS



THREE-BEDROOM GALLERY VILLA PLUS
LIVING AND DINING AREAS



THREE-BEDROOM SKYVIEW VILLA

11 UNITS

APPROXIMATE AREA RANGE

241 – 266 sqm

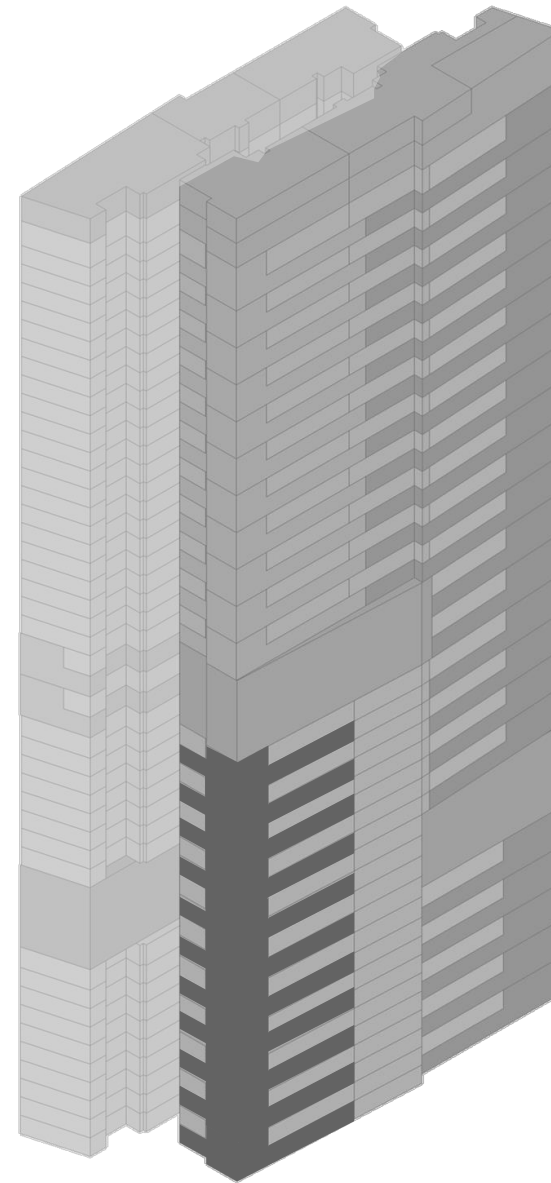

FACING URDANETA

THREE-BEDROOM SKYVIEW VILLA

11 UNITS

APPROXIMATE AREA RANGE

241 – 266 sqm

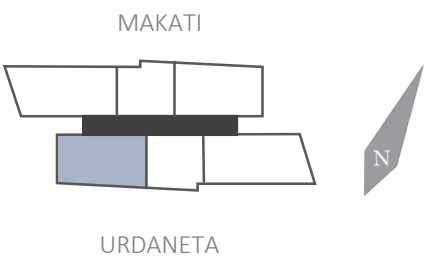
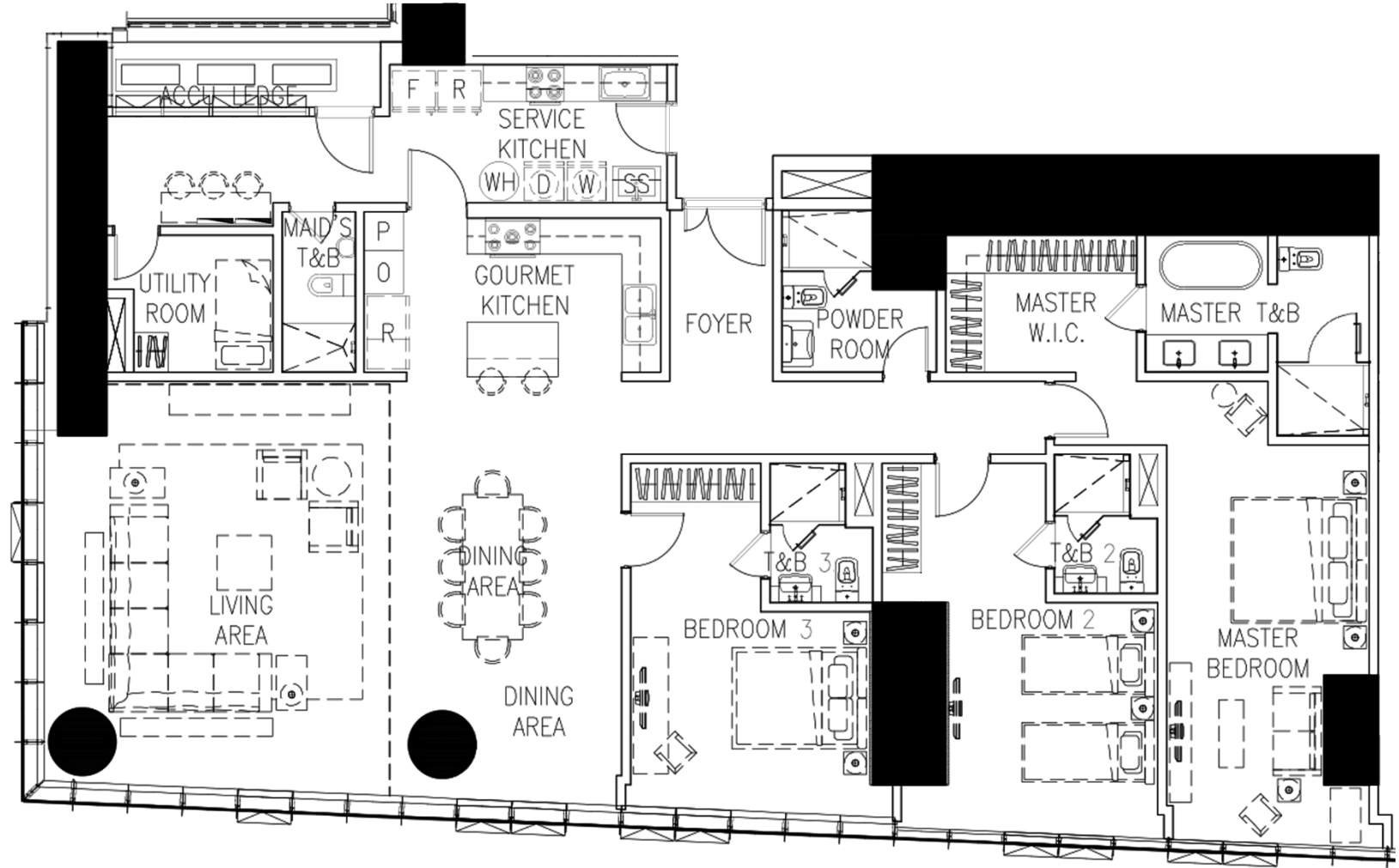

THREE-BEDROOM SKYVIEW VILLA
DINING AND DOUBLE-VOLUME LIVING AREAS



THREE-BEDROOM SKYVIEW VILLA PLUS

11 UNITS

APPROXIMATE AREA RANGE

265 – 266 sqm

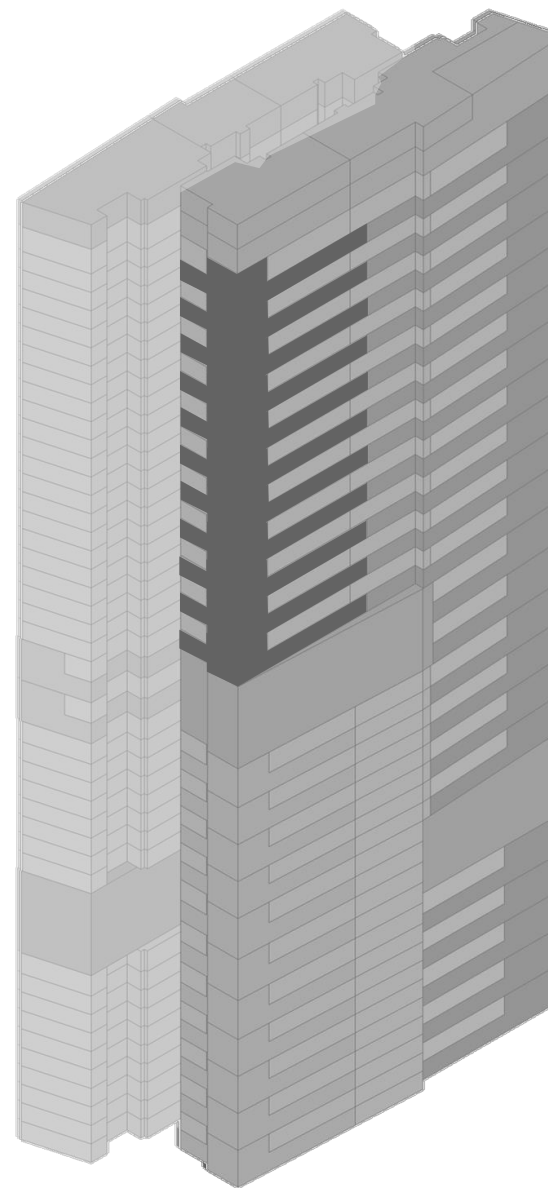

FACING URDANETA

LUXURY OF CHOICE

THREE-BEDROOM SKYVIEW VILLA PLUS

11 UNITS

APPROXIMATE AREA RANGE

265 – 266 sqm

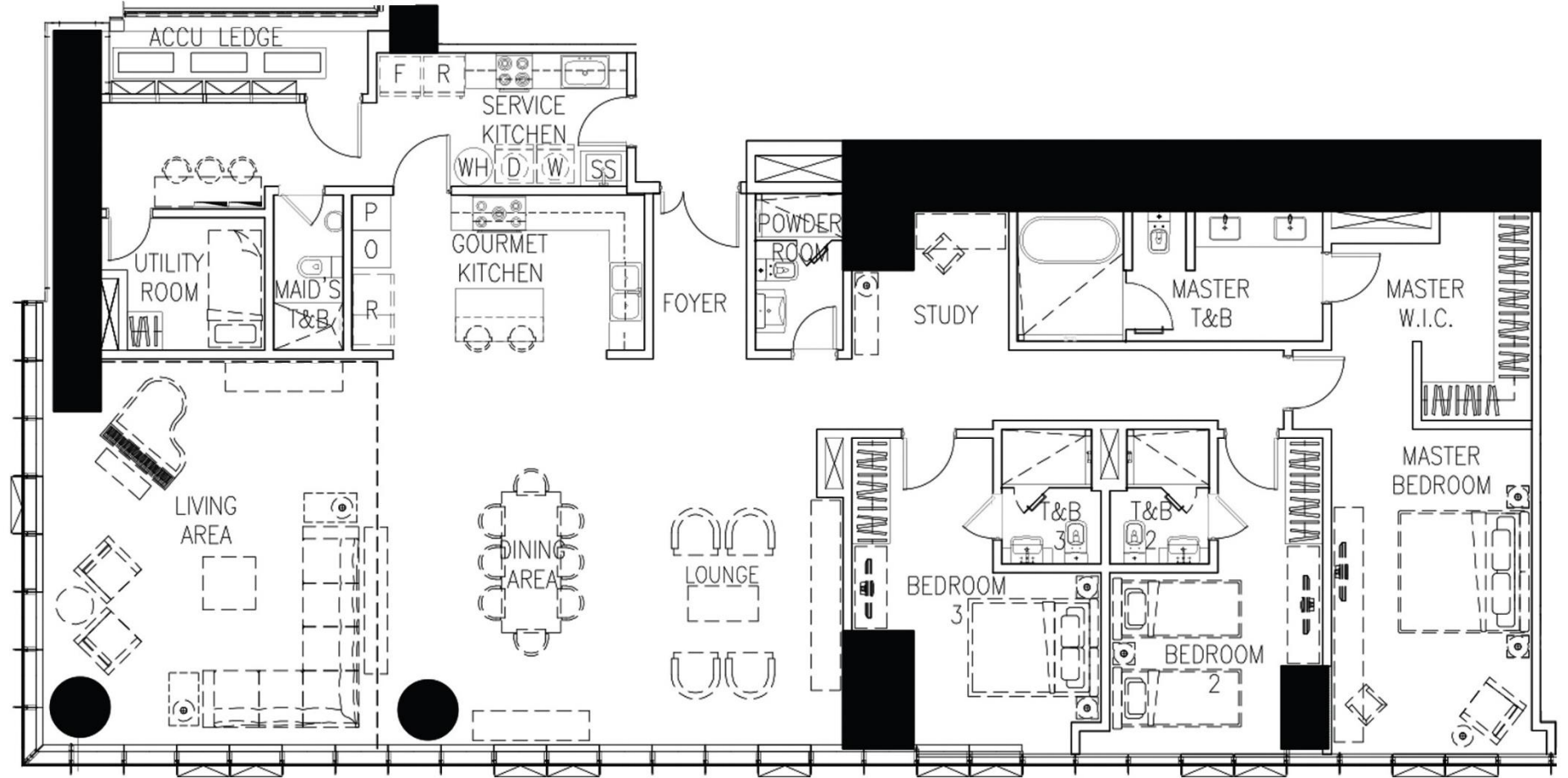

MAKATI

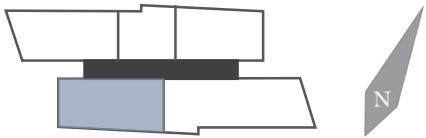

URDANETA

FOUR-BEDROOM SKYVIEW VILLA PLUS

2 UNITS

APPROXIMATE AREA

384 sqm

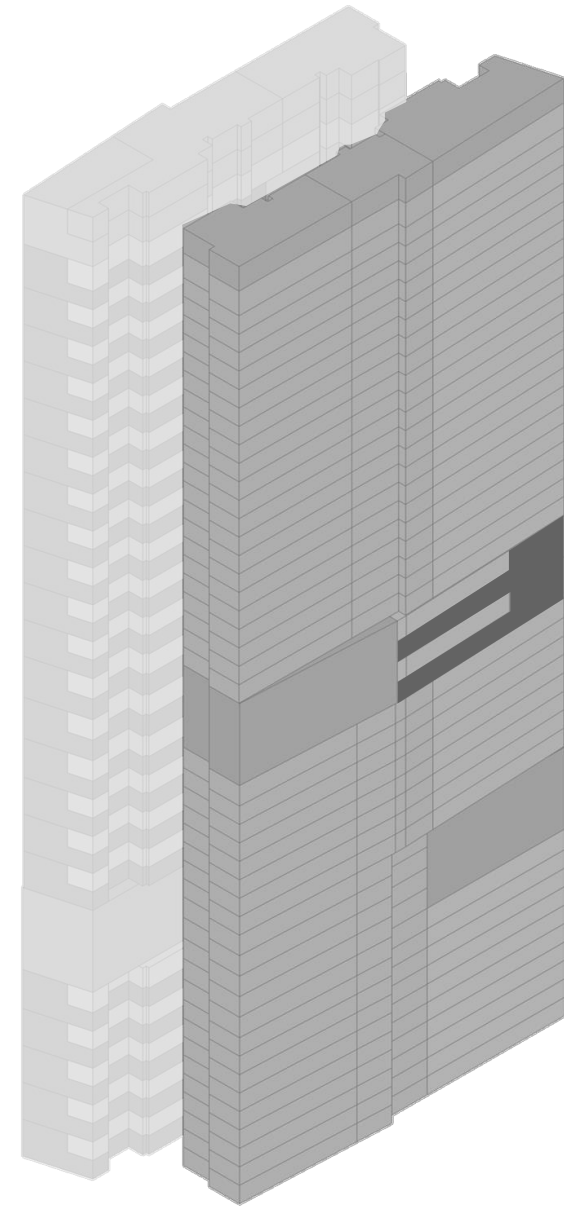

FACING MAKATI

LUXURY OF CHOICE

FOUR-BEDROOM SKYVIEW VILLA PLUS

2 UNITS

APPROXIMATE AREA

384 sqm

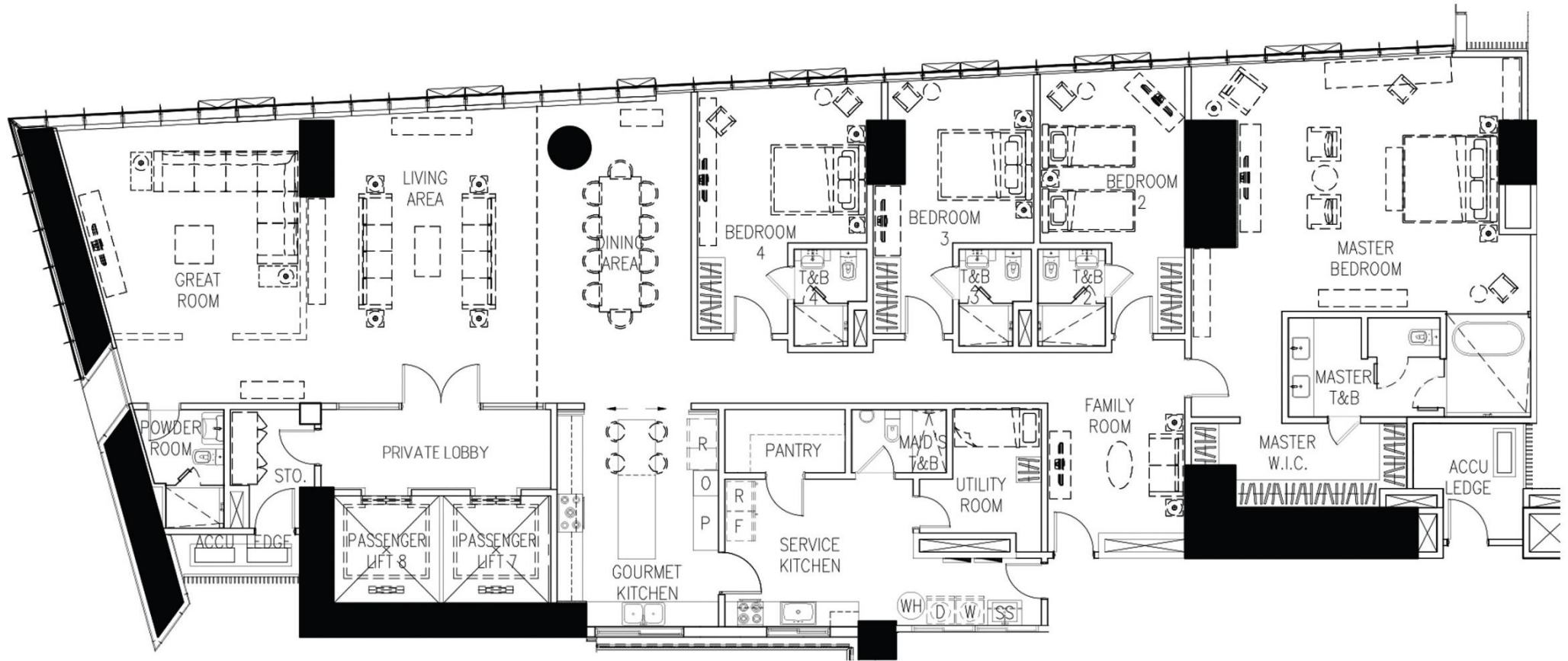

MAKATI

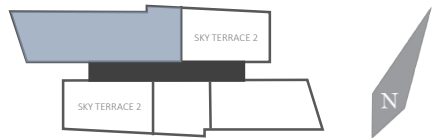

URDANETA

FOUR-BEDROOM SKYVIEW VILLA PLUS
EXTERIOR PERSPECTIVE OF THE DOUBLE-VOLUME LIVING AND DINING AREAS



THREE-BEDROOM AQUAVIEW VILLA

11 UNITS

APPROXIMATE AREA RANGE

286 - 304 sqm

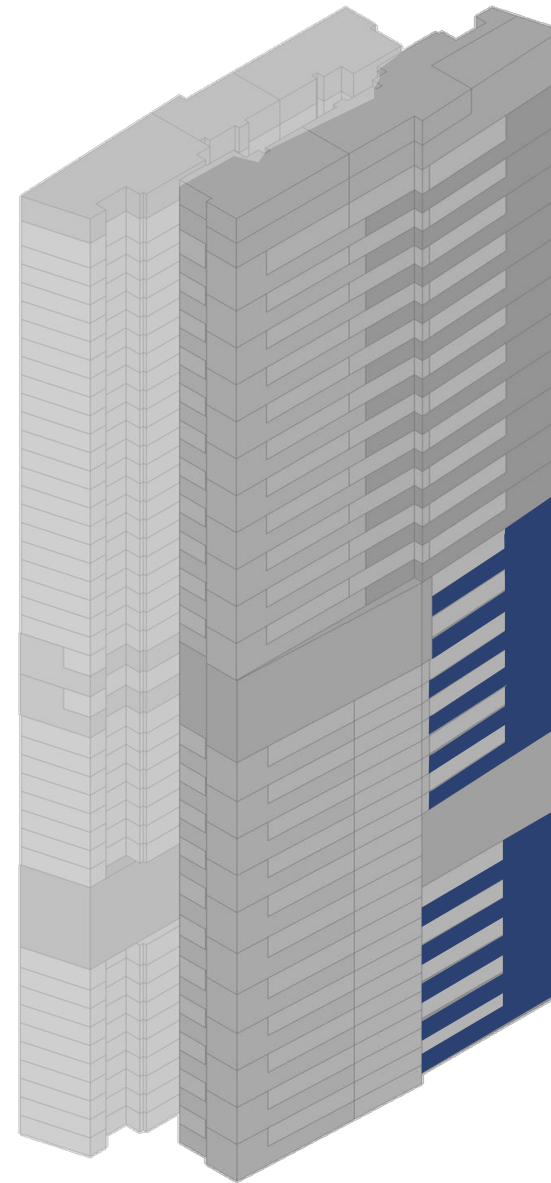

FACING URDANETA

THREE-BEDROOM AQUAVIEW VILLA

11 UNITS

APPROXIMATE AREA RANGE

286 - 304 sqm

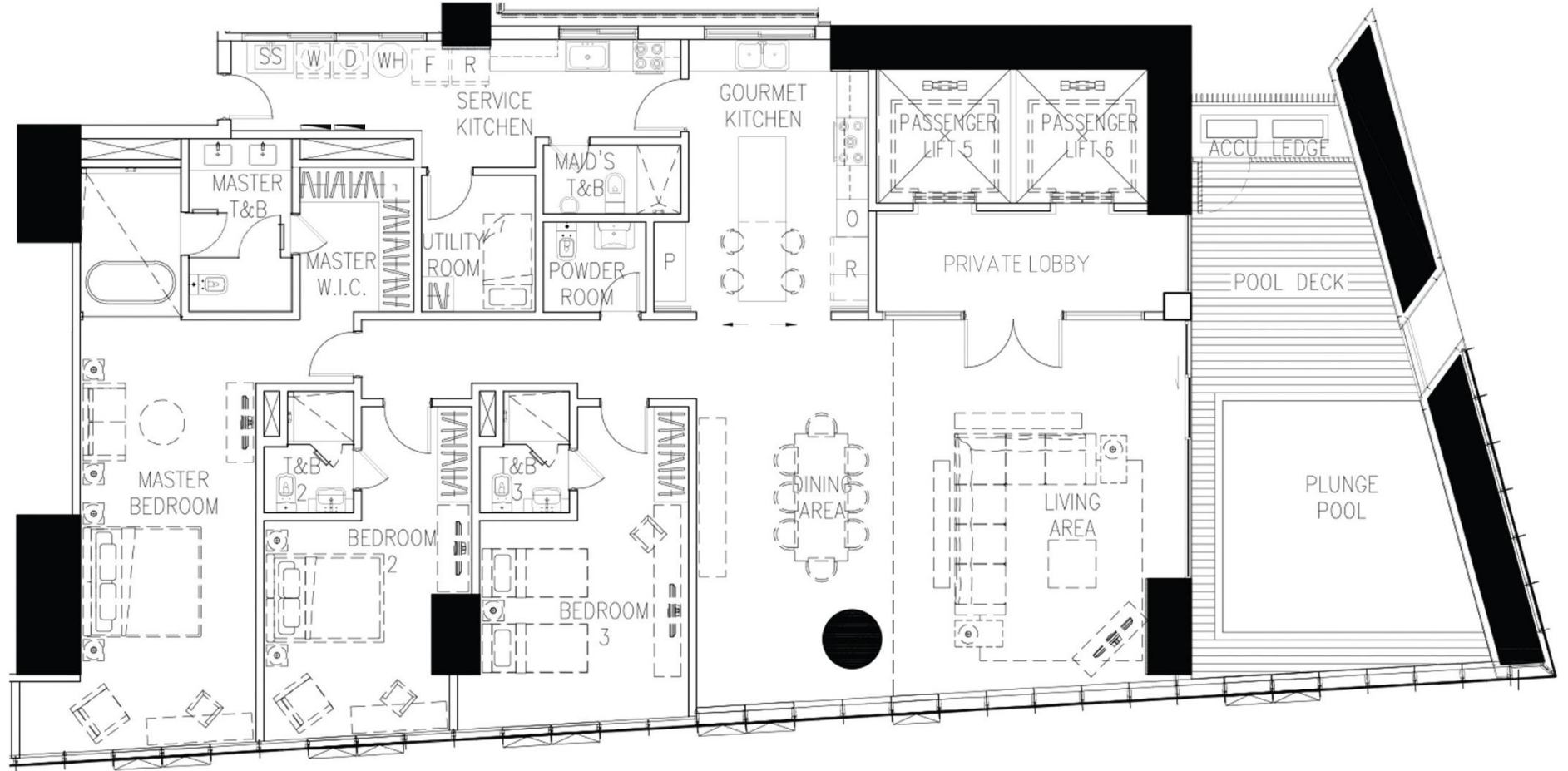

MAKATI



URDANETA

THREE-BEDROOM AQUAVIEW VILLA
DOUBLE-VOLUME LIVING AREA



FOUR-BEDROOM AQUAVIEW VILLA

11 UNITS

APPROXIMATE AREA RANGE

410 - 413 sqm

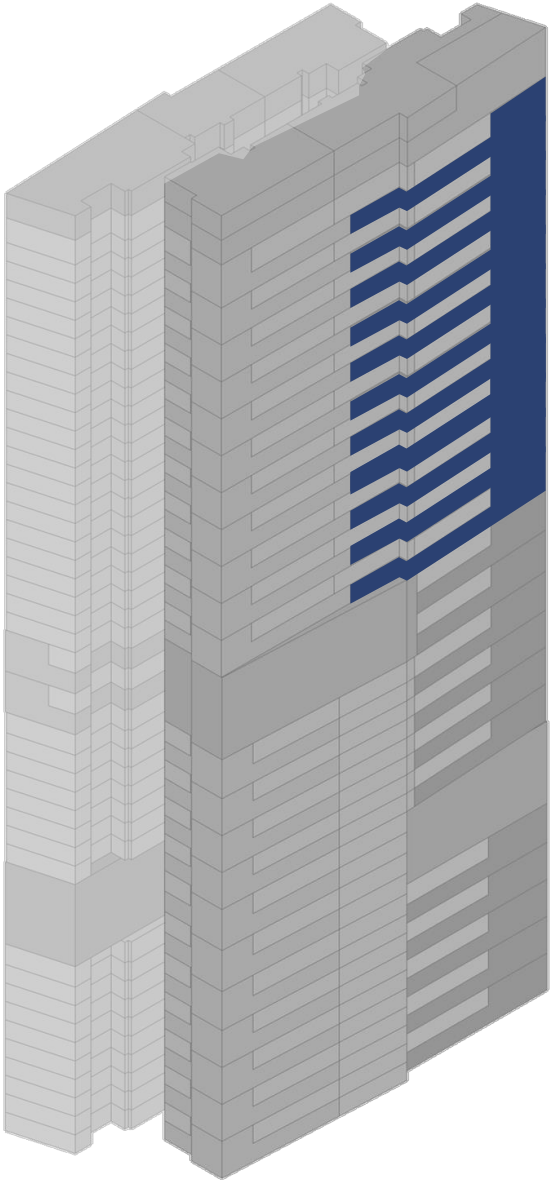

FACING URDANETA

FOUR-BEDROOM AQUAVIEW VILLA

11 UNITS

APPROXIMATE AREA RANGE

410 - 413 sqm

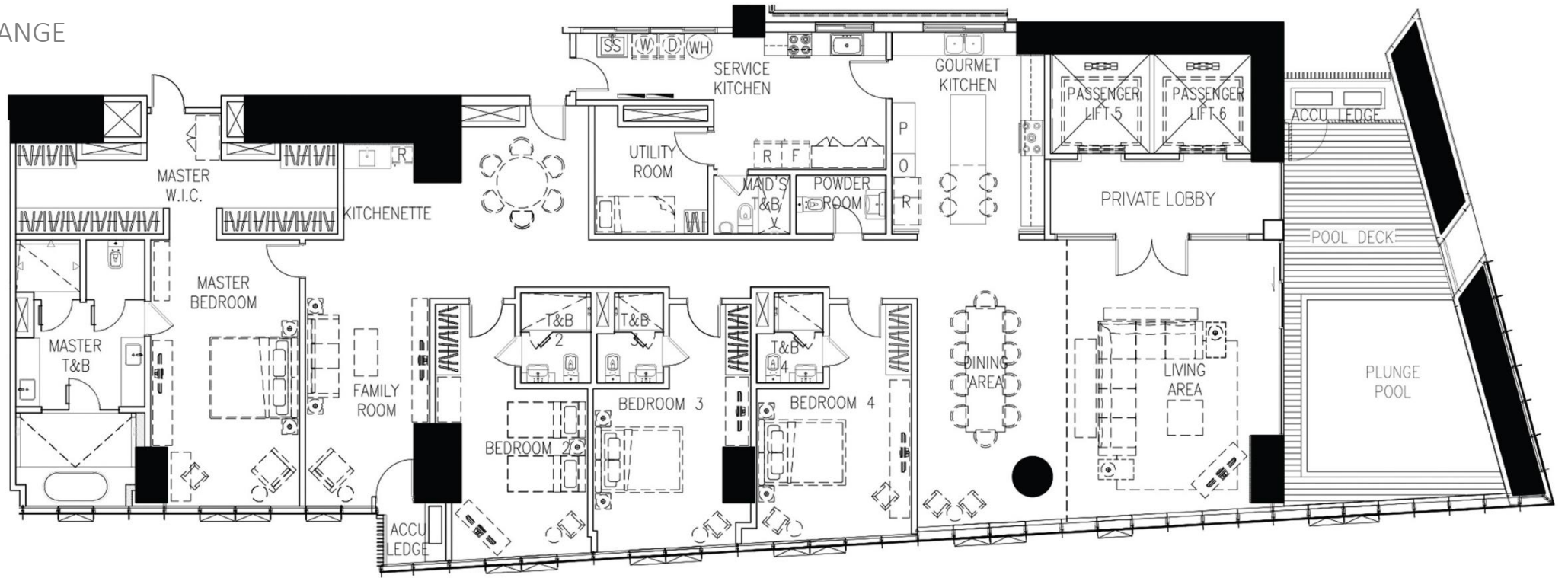

MAKATI

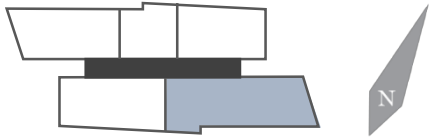

URDANETA

FOUR-BEDROOM AQUAVIEW VILLA
PRIVATE POOL AND DECK AREA



ANADEM COLLECTION

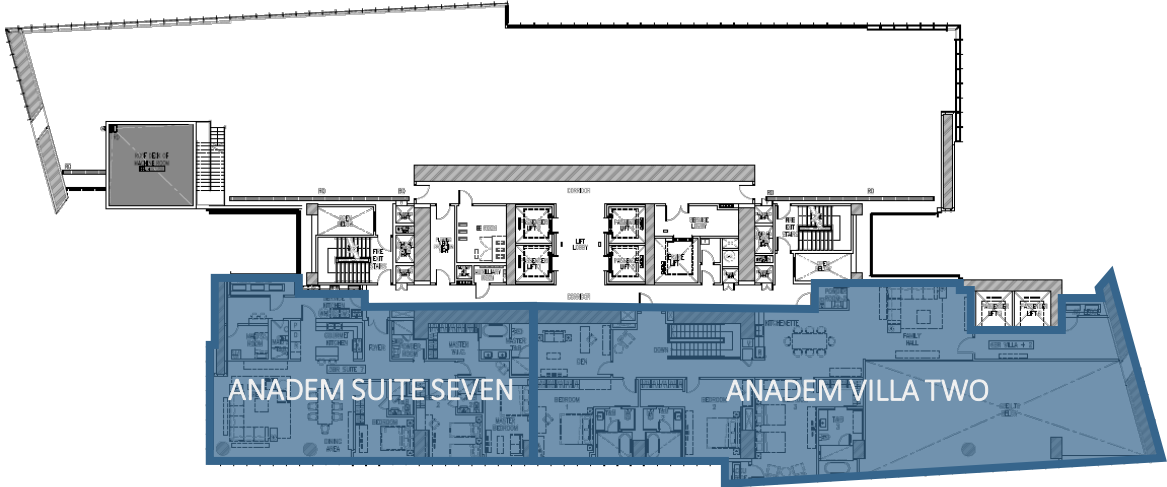

UPPER FLOOR PLATE 56th

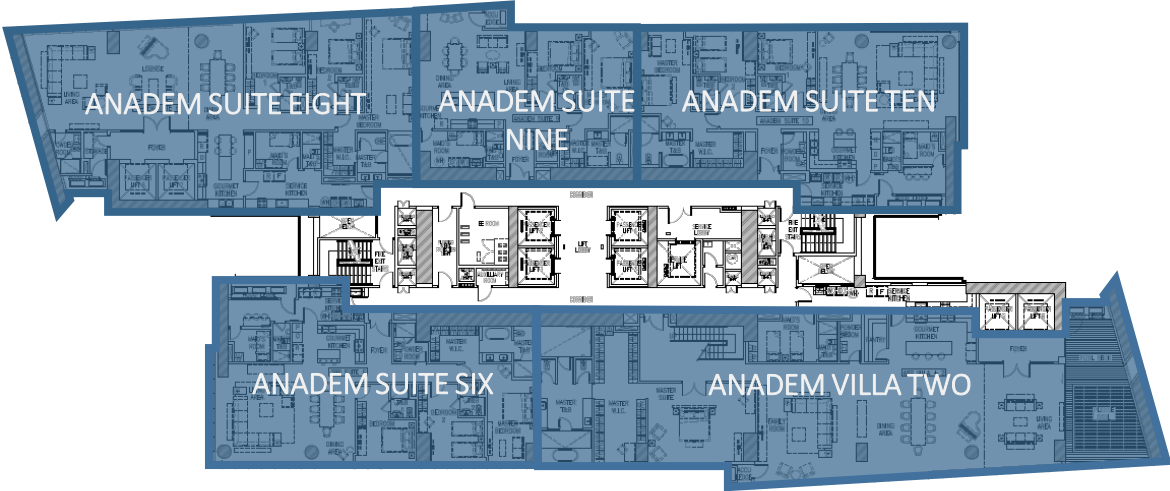

LOWER FLOOR PLATE 55th

ANADEM VILLA TWO

ANADEM SUITES SIX AND SEVEN

2 UNITS

APPROXIMATE AREA RANGE

234 – 235 sqm

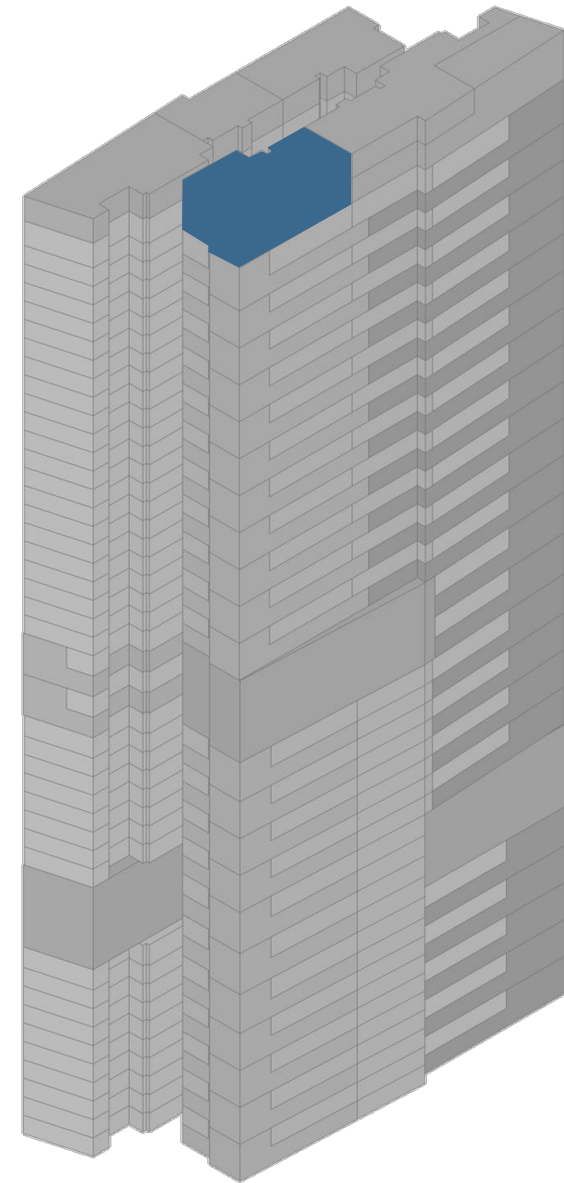

FACING URDANETA

ANADEM SUITES SIX AND SEVEN

2 UNITS

APPROXIMATE AREA RANGE

234 – 235 sqm

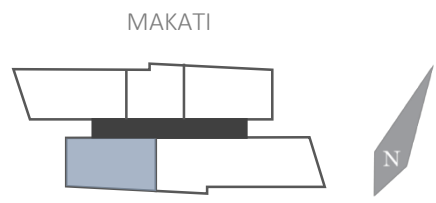
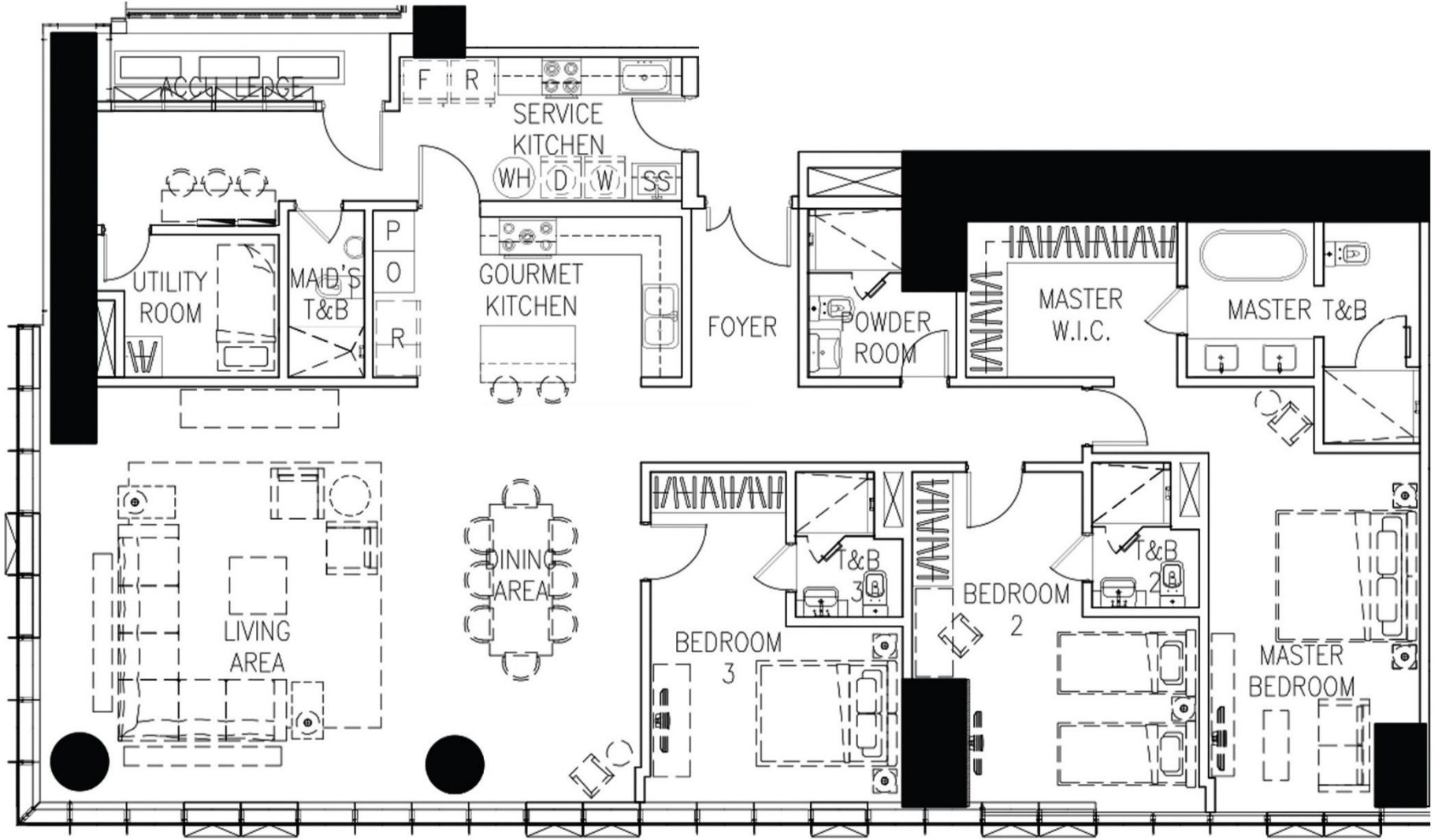

ANADEM SUITE EIGHT

1 UNIT

APPROXIMATE AREA

299 sqm



FACING MAKATI

ANADEM SUITE EIGHT

1 UNIT

APPROXIMATE AREA

299 sqm

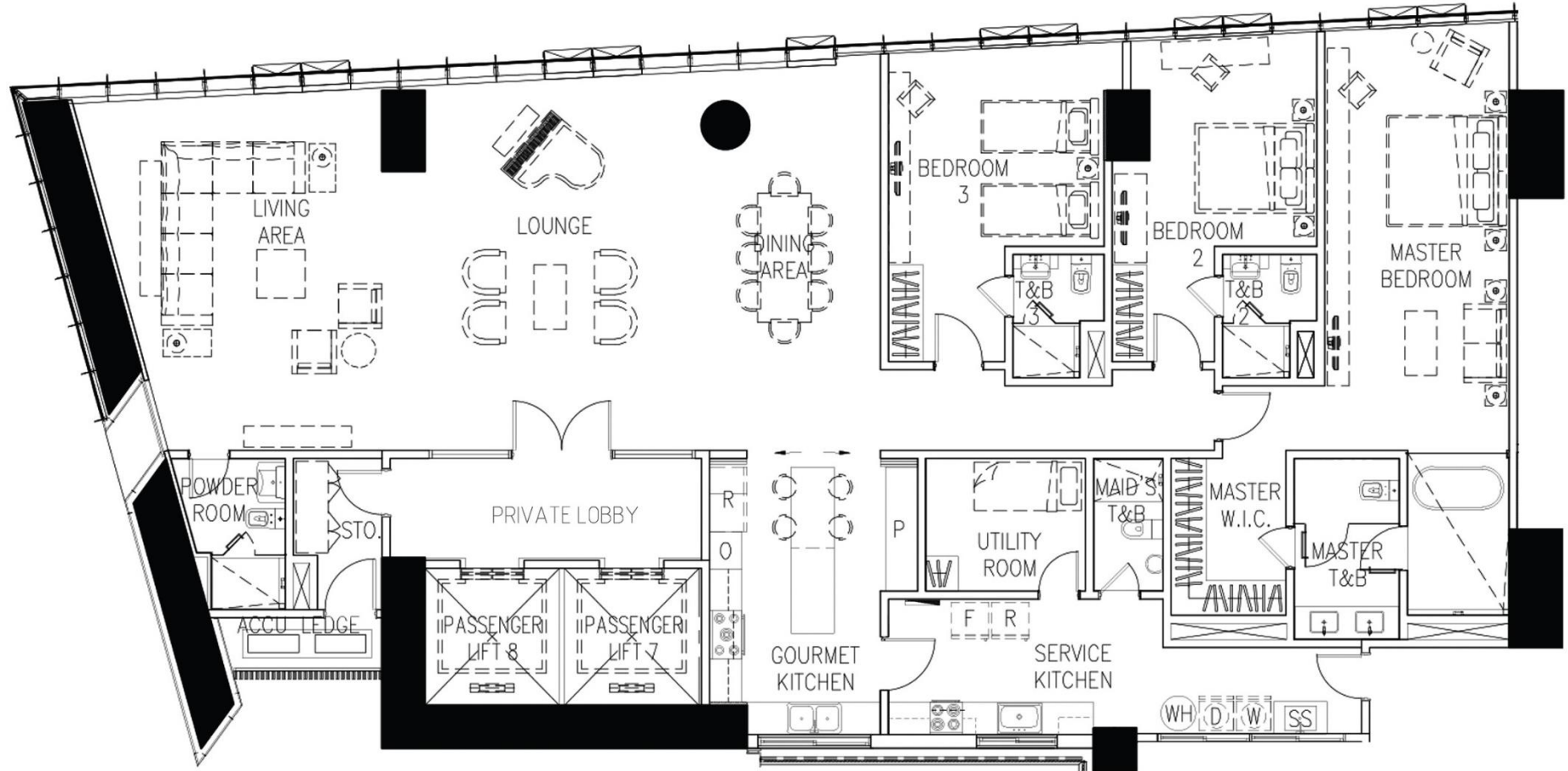

MAKATI

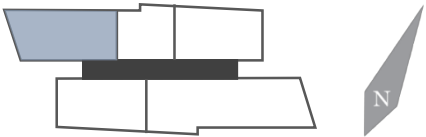

URDANETA

ANADEM SUITE NINE

1 UNIT

APPROXIMATE AREA

151 sqm

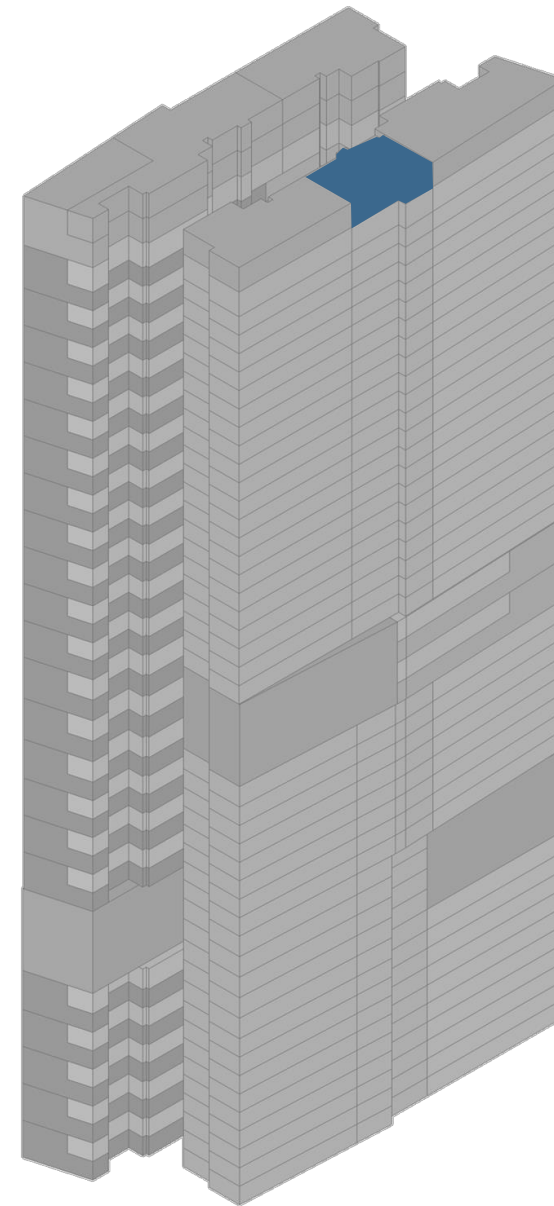

FACING MAKATI

ANADEM SUITE NINE

1 UNIT

APPROXIMATE AREA

151 sqm

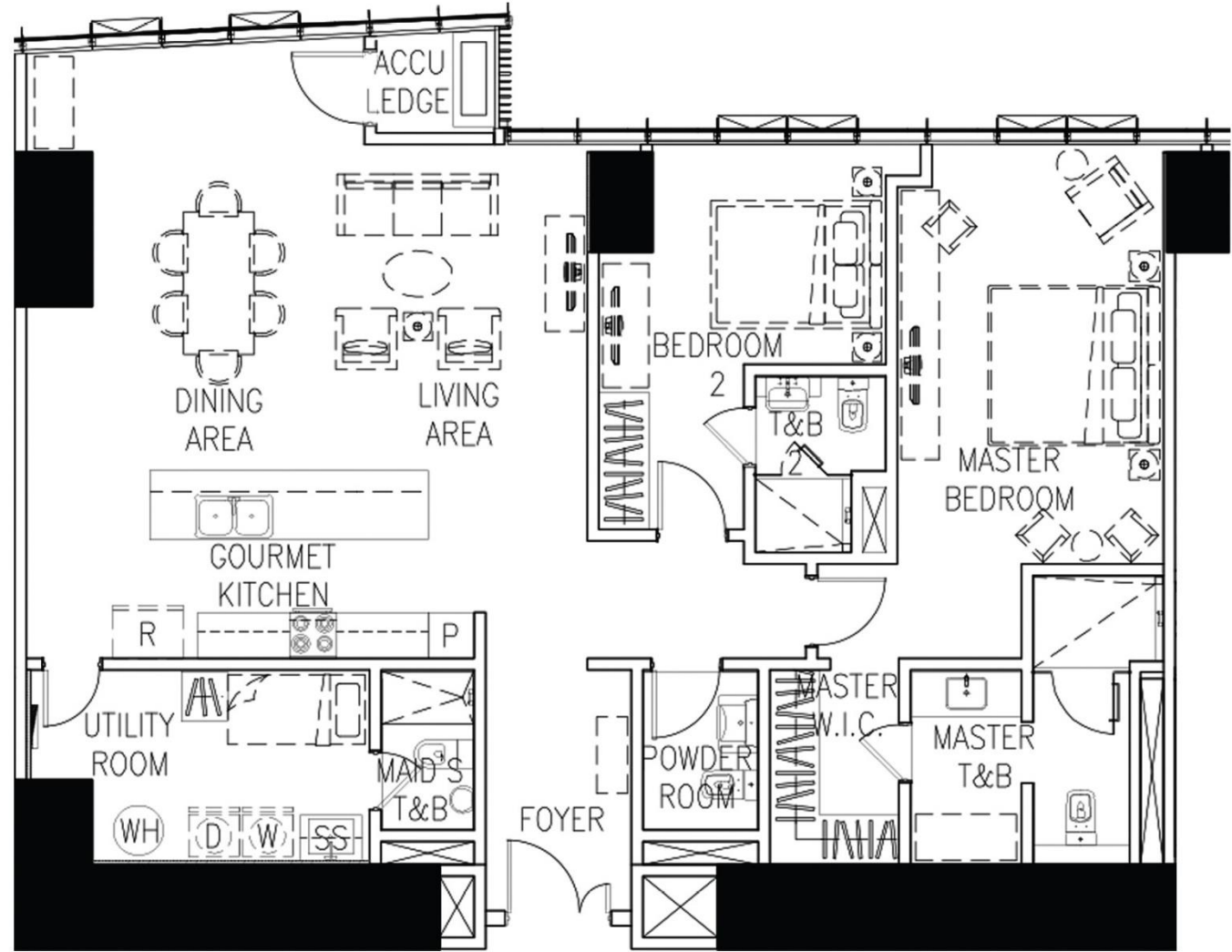

MAKATI

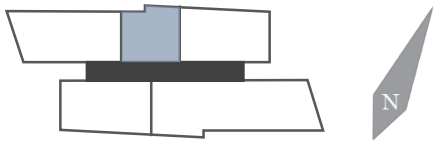

URDANETA

ANADEM SUITE TEN

1 UNIT

APPROXIMATE AREA

236 sqm



FACING MAKATI

ANADEM SUITE TEN

1 UNIT

APPROXIMATE AREA

236 sqm

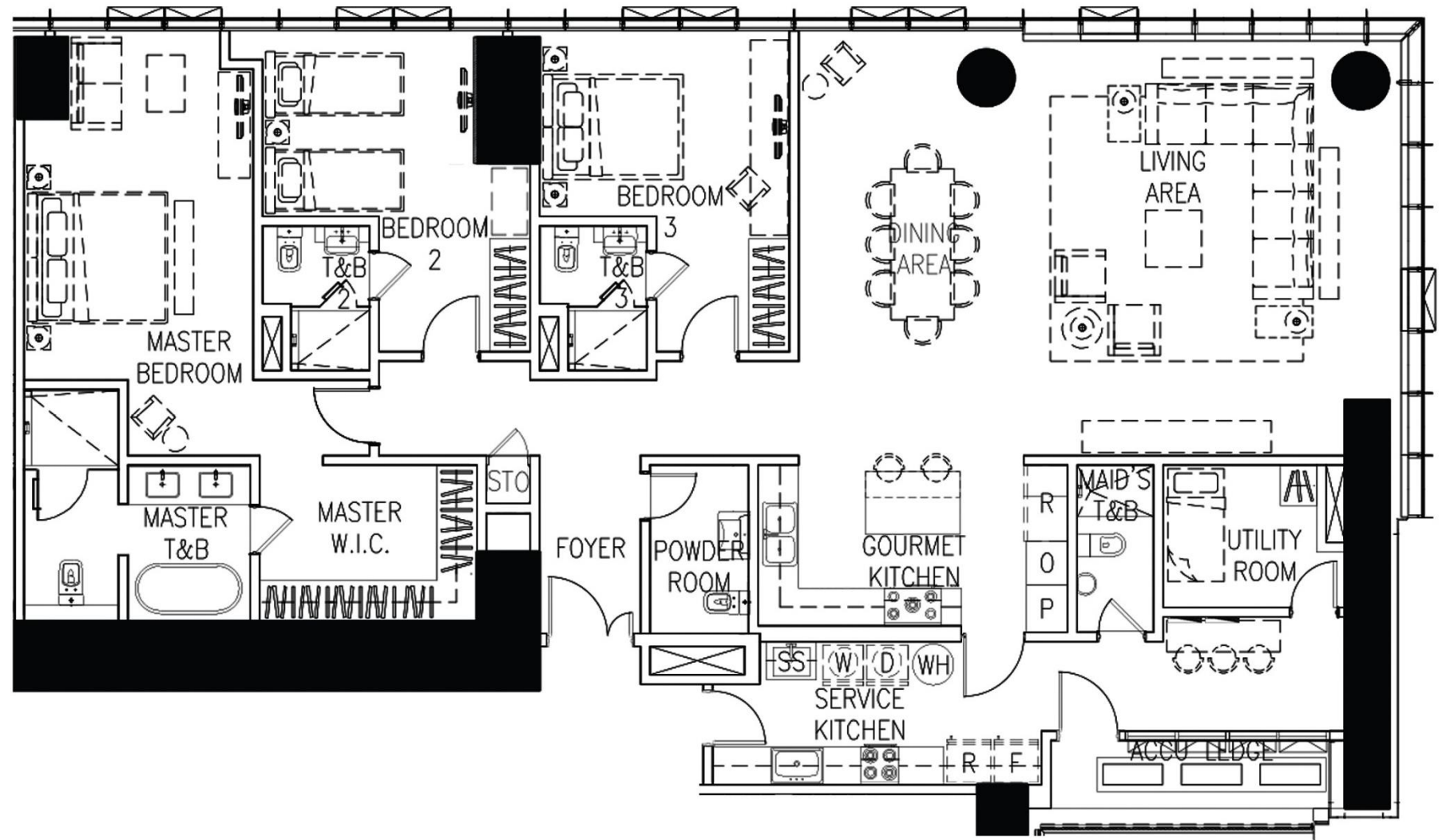

MAKATI

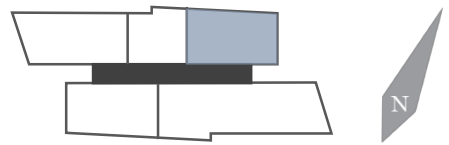

URDANETA

ANADEM VILLA TWO

1 UNIT

APPROXIMATE AREA

753 sqm

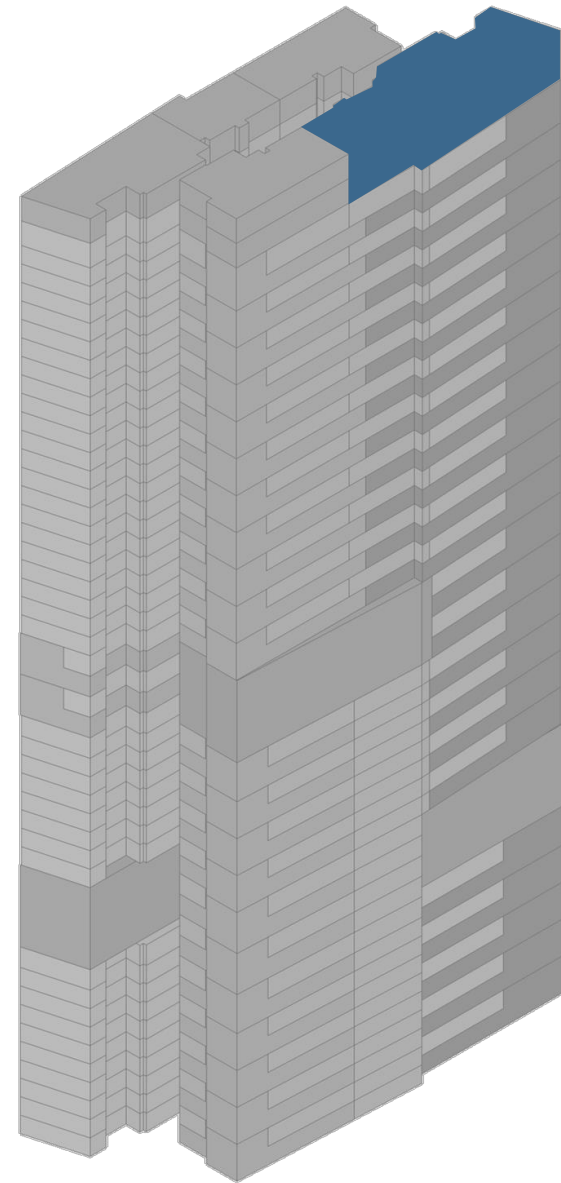

FACING URDANETA

ANADEM VILLA TWO

1 UNIT

APPROXIMATE AREA

754 sqm

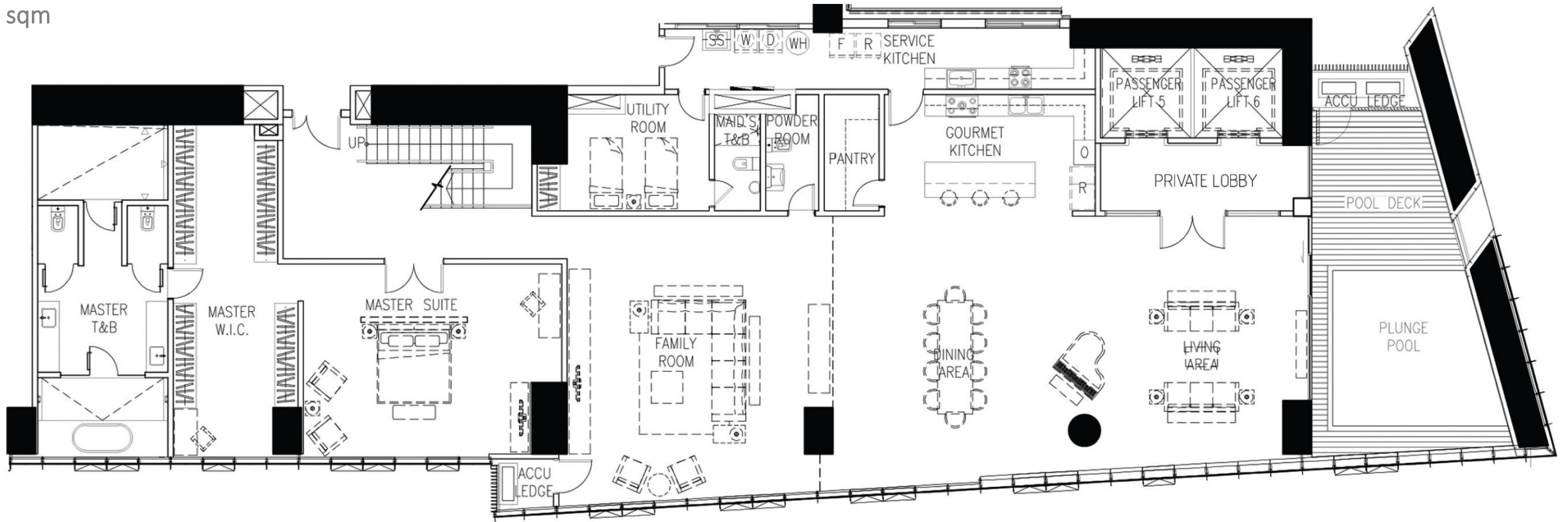

MAKATI

LOWER FLOOR APPROX. 448 SQM

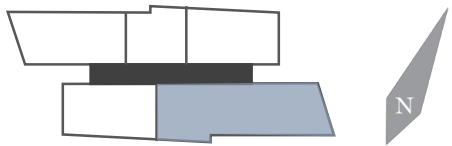

URDANETA

ANADEM VILLA TWO

1 UNIT

APPROXIMATE AREA

754 sqm

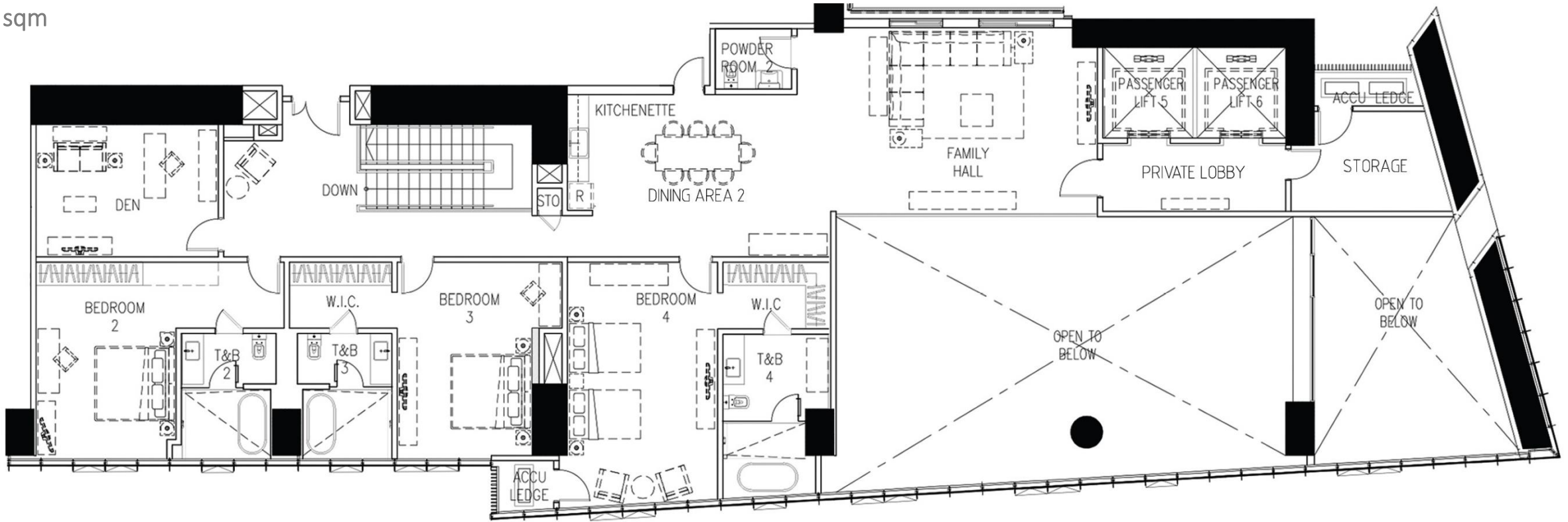

LOWER FLOOR APPROX. 305 SQM

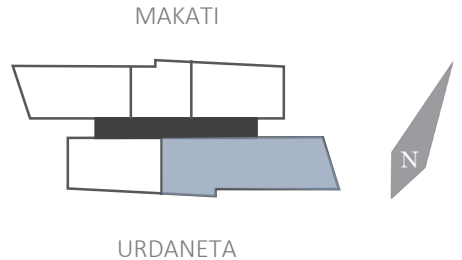

ANADEM VILLA TWO

EXTERIOR PERSPECTIVE OF THE SPRAWLING BI-LEVEL PENTHOUSE



UNIT
FINISHES
TYPICAL UNITS

ROOM/AREA	FLOOR	WALL	CEILING
Foyer	European Tile	Painted	Painted Gypsum
Living/Dining Area	European Tile	Painted	Painted Gypsum
Powder Room	European Tile	Painted	Moisture Resistant Painted Gypsum
Master Bedroom	Engineered Wood	Painted	Painted Gypsum
Master Toilet & Bath	European Tile	European Tile	Moisture Resistant Painted Gypsum
Master Walk-in-Closet	Engineered Wood	Painted	Painted Gypsum
Secondary Bedroom	Engineered Wood	Painted	Painted Gypsum
Secondary/Common Toilet & Bath	European Tile	European Tile in the Shower Area, Painted	Moisture Resistant Painted Gypsum
Den/Family Room*	European Tile	Painted	Painted Gypsum
Gourmet Kitchen	European Tile	Painted	Painted Gypsum
Utility Kitchen*	Homogeneous Tile	Painted	Painted Gypsum
Utility Room	Homogeneous Tile	Painted	Painted Gypsum
Maids' Toilet & Bath	Homogeneous Tile	Homogeneous Tile in the Shower Area, Painted	Moisture Resistant Painted Gypsum
Pool Deck	Composite Wood	Painted	Moisture Resistant Painted Gypsum

** Only applicable for certain unit types*

UNIT
FINISHES
ANADEM UNITS

ROOM/AREA	FLOOR	WALL	CEILING
Foyer	Natural Stone	Painted	Painted Gypsum
Living/Dining Area	Natural Stone	Painted	Painted Gypsum
Powder Room	European Tile	Painted	Moisture Resistant Painted Gypsum
Master Bedroom	Engineered Wood	Painted	Painted Gypsum
Master Toilet & Bath	European Tile	European Tile	Moisture Resistant Painted Gypsum
Master Walk-in-Closet	Engineered Wood	Painted	Painted Gypsum
Secondary Bedroom	Engineered Wood	Painted	Painted Gypsum
Secondary/Common Toilet & Bath	European Tile	European Tile in the Shower Area, Painted	Moisture Resistant Painted Gypsum
Den/Family Room*	Natural Stone	Painted	Painted Gypsum
Gourmet Kitchen	Natural Stone	Painted	Painted Gypsum
Utility Kitchen*	Homogeneous Tile	Painted	Painted Gypsum
Maids'/Utility Room	Homogeneous Tile	Painted	Painted Gypsum
Maids' Toilet & Bath	Homogeneous Tile	Homogeneous Tile in the Shower Area, Painted	Moisture Resistant Painted Gypsum
Pool Deck	Composite Wood	Painted	Moisture Resistant Painted Gypsum

** Only applicable for certain unit types*

UNIT FEATURES

European brand gourmet kitchen cabinets with built-in appliances (cooktop, rangehood, and oven)

Utility kitchen with built-in appliances (cooktop and rangehood)**

Other appliances provided in the unit:

Air-conditioning units for bedrooms* and living/dining areas

Water heaters for kitchen and bathrooms*

Private pools*

European brand bathroom fixtures*

Engineered wood flooring and homogeneous tile finishes

CATV provision for all bedrooms and living area

Provision for a choice between two telephone lines and data service providers per unit

Telephone outlets in all bedrooms*, kitchen, living, and dining areas

Individual metering for water and electricity

Audio-video guest annunciator system

Duress button in the master bedroom

*Except for maid's room/bathroom and utility

**For select units

AMENITIES

THIRD FLOOR

Multi-purpose Court

Bi-level Main Gym

Main Social Hall

Secondary Social Hall

Residents' Lounge

Game Room

Indoor Play Area

Main Pool

Kiddie Pool

Pool Deck & Landscaped Areas

SKY TERRACES AT THE 16TH and 28TH FLOORS

Outdoor Lounge and Pool

Fitness Gym and Studio

SAFETY AND SECURITY

Fire detection and alarm

24-hour security and building maintenance

Proximity card access for parking levels, elevators, and amenities

100% back-up power

Integrated CCTV Security System in select common areas

TURNOVER

SOUTH TOWER

Beginning 1Q, 2024

NORTH TOWER

Beginning 4Q, 2025



For your future investment, contact :

Rochelle S. Suarez

 +63 906 778 9955(Whatsapp/Viber/iMessage/Ph#)

 suarezrochelle@yahoo.com

PARK CENTRAL TOWERS

NORTH TOWER TLTS ENCRFO NO. 17-09-019 | ENCR AA-2017/10-1936

LOCATION: PASEO DE ROXAS COR. MAKATI AVENUE, MAKATI CITY

COMPLETION DATE: DECEMBER 2025

PROJECT DEVELOPER: AYALA HOTELS, INC.